

JAERI-M
92-058

A RESEARCH ON APPLICATIONS OF
QUALITATIVE REASONING TECHNIQUES IN
HUMAN ACTS SIMULATION PROGRAM

April 1992

Behrouz HOMAYOUN FAR

A Research on Applications of Qualitative Reasoning Techniques in Human Acts Simulation Program

Behrouz Homayoun Far¹

Computing and Information Systems Center
Tokai Research Establishment
Japan Atomic Energy Research Institute
Tokai-mura, Naka-gun, Ibaraki-ken

(Received March 18, 1992)

Human Acts Simulation Program (HASP) is a ten-year research project of the Computing and Information Systems Center of JAERI. In HASP the goal is developing programs for an advanced intelligent robot to accomplish multiple instructions (for instance, related to surveillance, inspection and maintenance) in nuclear power plants. Some recent artificial intelligence techniques can contribute to this project. This report introduces some original contributions concerning application of Qualitative Reasoning (QR) techniques in HASP. The focus is on the knowledge-intensive tasks, including model-based reasoning, analytic learning fault diagnosis and functional reasoning. The multi-level extended qualitative modeling for the Skill-Rule-Knowledge (S-R-K) based reasoning, that included the coordination and timing of events, Qualitative Sensitivity analysis (QSA), Subjective Qualitative Fault Diagnosis (SQD) and Qualitative Function Formation (QFF) techniques are introduced.

Keywords:

Qualitative reasoning, Model based learning, Fault diagnosis, Functional reasoning.

¹ JAERI Research Fellow.

Contact address of the author (from April 1, 92): Department of Information and Computer Sciences, Saitama University, 255 Shimo-okubo, Urawa 338, Japan.

人間動作シミュレーションにおける 定性推論の研究

日本原子力研究所東海研究所情報システムセンター

Behrouz Homayoun Far¹

(1992年 3月 18日 受理)

情報システムセンターでは、原子力知能化システム技術の研究テーマの中で人間動作シミュレーション・プログラム (Human Acts Simulation Program: HASP) と名付けた人工知能とロボティクスに関する研究を行っている。具体的には、原子力施設の保守点検作業を対象として、知能ロボットが与えられた作業命令を解釈、実行する為に必要なソフトウェア及びハードウェアの研究開発を行うものである。本レポートでは、HASP における人工知能の研究の1つである定性推論の研究と応用、つまり、モデルベース推論と学習、故障診断、そして機能推論等について述べる。技能・ルール・知識 (S-R-K) 構造と対応する時間的な状態変化とその同期を含めた定性モデルの階層構造、定性感度解析手法、主観的な定性故障診断手法、そして定性機能形成手法を紹介する。

¹ JAERI リサーチフェロー。

現住所 (92年4月から): 埼玉大学情報工学科、〒338 埼玉県浦和市下大久保255。

Contents

1	Introduction	1
2	Research on Model Based Reasoning: A Multi-Level Qualitative Model for the Skill-Rule-Knowledge Based Reasoning	4
2.1	Introduction	4
2.2	Qualitative Reasoning: Background	5
2.3	Conceptual Models: Background	5
2.4	Qualitative Deep Model	6
2.4.1	Qualitative Flow Graph	10
2.4.2	Qualitative Processes	11
2.4.3	Behavioral Fragments	12
2.5	Qualitative Compiled Model	14
3	Research on Model Based Learning: A Model Based Learning Technique for Generating Shallow Rules-of-Thumb from Deep Qualitative Model	22
3.1	Introduction	22
3.2	Qualitative Sensitivity Analysis	23
3.3	Generating Shallow Rules of Thumb	25
3.4	Discourse Understanding System	26
4	Research on Subjective Fault Diagnosis: A Subjective Approach to Qualitative Fault Diagnosis in Systems with Nonintermittent Concurrent Faults	29
4.1	Introduction	29
4.2	Conventional Fault Diagnosis: A Comparative Survey	30
4.2.1	Structure Oriented Approach	31
4.2.2	Procedure Oriented Approach	31
4.2.3	Subjective Approach	32
4.3	Subjective Qualitative Fault Diagnosis Technique	33
4.3.1	Knowledge Based Level	33
4.3.2	Rule Based Level	34
4.3.3	Hierarchy of Knowledge and Rule Based Levels	34
4.4	Knowledge Based Level Qualitative Fault Diagnosis	34
4.4.1	Qualitative Observed Behavior	34
4.4.2	Diversified Behavioral Fragment	35
4.4.3	Detecting Candidate Faults	37
4.5	Validating Concurrent Fault Hypotheses	39
4.6	Rule Based Level Qualitative Fault Diagnosis	40
4.7	Situation Assessment	42
5	Research on Functional Reasoning: Qualitative Function Formation Technique	48
5.1	Introduction	48
5.2	Functional Reasoning Problems	50
5.2.1	Informal Problems	50
5.2.2	Formal Problems	50

5.3	Functional Reasoning Systems	51
5.3.1	History: Functional Reasoning in Biology and Design	52
5.3.2	First Generation Functional Reasoning Systems	53
5.3.3	Second Generation Functional Reasoning Systems	53
5.3.4	Planning and Design Systems	53
5.3.5	Explanation Based Systems	55
5.3.6	Conceptualization Systems	57
5.4	Qualitative Function Formation Technique	58
5.4.1	Basic Assumptions	58
5.4.2	Overview	59
5.4.3	Detecting Repetitions in Behavior	60
5.5	Design Verification Using Qualitative Function Formation	60
5.5.1	Identification of Functions	61
5.5.2	Case 1. Design Preference for Safety: Fault Diagnosis	63
5.5.3	Case 2. Design Preference for Safety: Safety Margin	64
5.5.4	Explanation of Functions	65
5.5.5	Selection of Components	67
6	Summary	78
6.1	A Research on Model Based Reasoning	78
6.2	A Research on Model Based Learning	78
6.3	A Research on Subjective Fault Diagnosis	79
6.4	A Research on Functional Reasoning	79

目次

1	はじめに	1
2	定性モデル化の研究：技能・ルール・知識（S-R-K）構造と対応する 定性モデルの階層構造	4
2.1	はじめに	4
2.2	定性推論に関する調査	5
2.3	概念構造に関する調査	5
2.4	定性モデル化：知識レベル	6
2.5	定性モデル化：ルール・レベル	14
3	定性学習の研究：知識レベル定性モデルによる浅いルールの生成と学習	22
3.1	はじめに	22
3.2	定性感度解析手法	23
3.3	浅いルールの生成	25
3.4	デイスコース・システム	26
4	主観的な故障診断の研究：多重故障診断に対する主観的研究法	29
4.1	はじめに	29
4.2	故障診断システムに関する調査	30
4.3	主観的な定性故障診断手法	33
4.4	知識ベースレベル定性故障診断	34
4.5	多重故障の正当性を立証	39
4.6	ルールベースレベル定性故障診断	40
4.7	評価システム	42
5	機能推論の研究：定性機能形成手法	48
5.1	はじめに	48
5.2	機能推論の具体的課題	50
5.3	機能推論システムに関する調査	51
5.4	定性機能形成手法	58
5.5	定性機能形成手法による設計論	60
6	おわりに	78
6.1	定性モデル化の研究	78
6.2	定性学習の研究	78
6.3	主観的な故障診断の研究	78
6.4	機能推論の研究	79
	謝辞	80
	参考文献	81

List of Figures

2.1	Double pressure tank system.	17
2.2	Qualitative modeling and reasoning.	18
2.3	Hierarchical model of human behavior along with the associated modeling and reasoning techniques.	19
2.4	Qualitative flow graph for the pressure tank system.	20
2.5	Reduction rules for lumped processes.	21
3.1	Qualitative sensitivity analyzer.	28
4.1	Qualitative structure oriented approach to fault diagnosis.	44
4.2	Procedure oriented approach to fault diagnosis.	45
4.3	Fundamental problems manifesting human performance in fault diagnosis.	46
4.4	Subjective qualitative fault diagnosis system.	47
5.1	Functional reasoning techniques and systems.	69
5.2	Three first generation functional reasoning systems.	70
5.3	Two network models for an object.	71
5.4	Overview of the qualitative function formation technique.	72
5.5	An example of windows of the qualitative function formation system.	73
5.6	Repetition cycle detection algorithm.	74
5.7	Qualitative model of the three design preferences for the tank T_1	75
5.8	Behavior for the tank T_1 when level passes a critical value.	76
5.9	Qualitative model for the tank T_2 when the level is maintained at $H_{(T_2)fix}$	77

List of Tables

1.1	Typical surveillance, inspection and maintenance tasks in nuclear power plants.	3
2.1	Clock and dependency constraints for extended qualitative expressions.	8
4.1	Test results for fault hypotheses of Case 1.1.	41
4.2	Test results for fault hypotheses of Case 2.1.	41
4.3	Test results for fault hypotheses of Case 2.2.	42
5.1	Functional primitives.	57
5.2	Contribution of components to the function of pressure tank system.	66

Chapter 1

Introduction

Human Acts Simulation Program (HASP) is a ten-year research project of the Computing and Information Systems Center of JAERI. In HASP the goal is developing programs for an advanced intelligent robotics system to accomplish multiple instructions (for instance, related to surveillance, inspection and maintenance) in nuclear power plants. Typical surveillance, inspection and maintenance tasks are listed in Table 1.1. In this report the focus is on the knowledge-intensive tasks including model-based reasoning, learning, fault diagnosis and functional reasoning. Original contributions arising from this research are described briefly herewith and explained in detail in the following chapters.

A Research on Model Based Reasoning:

Chapter 2 discusses the extended qualitative modeling and reasoning techniques. A multi-level qualitative models for representing the objects, useful for reasoning and decision making within the Skill-Rule-Knowledge (S-R-K) levels of behavior of humans is introduced. Qualitative Deep Model (Q^D_M) is the model for knowledge-based level of behavior. Q^D_M embodies the comprehensive knowledge about the objects and can be used for simulation of behavior and reasoning in some tasks such as inspection and diagnosis. Qualitative Compiled Model (Q^C_M) is the model for rule-based level of behavior. Q^C_M has the rule-based format. Q^C_M resembles an expert knowledge base which can be updated through model-based learning and is applicable to some tasks such as discourse understanding. Some novel points are systematic generation of Q^C_M from Q^D_M ; extending the common qualitative models to include interactions and timing of events, by defining temporal and dependency constraints; and binding them with the conventional qualitative simulation. These models serve as the basis for the reasoning in the subsequent chapters.

A Research on Model Based Learning:

In robot programming efficient learning algorithms for encoding the experiences gained in problem solving through a comprehensive analysis of a system are highly appreciated. The results of such analysis can be used for augmentation and refinement of the expertise embedded in the shallow rules-of-thumb. In Chapter 3 a model-based learning technique for generating shallow rules-of-thumb from deep qualitative models (i.e. knowledge level model) by means of Qualitative Sensitivity Analysis (QSA) is addressed. The generated rules are explainable in terms of the deep model, therefore more accurate and reliable than heuristic based rules in conventional expert systems. Application of QSA to model-based discourse understanding is reported.

A Research on Subjective Fault Diagnosis:

In Chapter 4 the methods developed in earlier chapters are put together to show their practical applicability in a typical complex task such as subjective fault diagnosis. The subjective approach imitates and synthesizes the way that human experts diagnose faults, as opposed to objective approach that automates a portion of diagnosis task that human's cognitive limitation does not allow handling it efficiently. Currently available subjective fault diagnosis techniques suffer from certain drawbacks such as: lack of knowledge for modeling and reasoning with the required levels of detail; inefficiency in utilization of sensory data; and poor in learning experienced schemata. In this chapter the Subjective Qualitative Fault Diagnosis ($SQFD$), using qualitative modeling and reasoning within the multiple view of the system, modeled by QDM and QCM is introduced. The focus is on automation of the cognitive skills of human experts, that include utilizing conceptual models to detect inherent redundancy in system behavior; qualitative reasoning to predict future states; and information selection to avoid computation overload.

A Research on Functional Reasoning:

Chapter 5 introduces the Qualitative Function Formation (QFF) technique. A collective viewpoint on the conventional functional reasoning theories and techniques is presented and two basis assumptions, 'functionality in component pair' and 'functionality in state transition' are identified. Function concepts are defined as interpretations of a persistence or an order in the sequence of states, using the trace of the qualitative state vector derived by qualitative simulation on the extended qualitative model. In terms of the extended qualitative model, the Qualitative Flow Graph (QFG) depicts interactions expressed by physical laws as well as interactions representing a kind of timing and coordination, coded by temporal and dependency constraints. Qualitative processes relate a characteristic feature of the component pair to the effects they have on the system. Such effects are described by Behavioral Fragments (BFs). The QFF technique offers solution to some of the functional reasoning problems and is used for generalization

and comparison of functions of objects.

Finally, Chapter 6 summarizes the achievements and results.

Table 1.1: Typical surveillance, inspection and maintenance tasks in nuclear power plants.

- | | |
|----|---|
| 1 | . Infra-red scan; |
| 2 | . Pipe or tube X-raying; |
| 3 | . Spill or leak monitoring and clean up; |
| 4 | . Measuring radiation and contamination levels; |
| 5 | . Equipment/instrument status verification; |
| 6 | . Searching for causes of malfunctioning; |
| 7 | . Measuring noise and vibration; |
| 8 | . Reactor containment inspection; |
| 9 | . Worker observation in hazardous areas; |
| 10 | . Repairing or replacing faulty components; |
| 11 | . Equipment and tool transportation; |
| 12 | . Fire fighting; |

Chapter 2

Research on Model Based Reasoning: A Multi-Level Qualitative Model for the Skill-Rule-Knowledge Based Reasoning

2.1 Introduction

Humans use models routinely and habitually to understand and interact with reality [94]. Models reflect how the objects in the external world interact and behave, and provide a basis for simulation and reasoning. Such models fall within two main categories: *topological* and *conceptual*. Topological world models embody geometric relation of objects in the world and reflect how the objects are arranged. Conceptual world models, on the other hand, specify how the objects interact and behave. Both models are necessary for reasoning and decision making. For instance, a robot moves towards a destination point, uses its knowledge of topological structure of the world, combining the built-in maps with the sensory information, to locate the objects such as walls, paths, stairways, etc. After getting to the destination point in order to accomplish tasks such as inspection or repairing a faulty component it uses functional knowledge of how actually that component behaves. Conventionally, these latter tasks are mainly performed through tele-automation.

The focus in this report is on systematic generation and reasoning with the conceptual models that describe and account for human understanding capabilities [7]. Operators of industrial plants when engaged in a goal-oriented activity, gradually produce a conceptual (mental reference) model of how the plant works based on standard plant operating procedures. Such models can further be applied to the situations for which no defined procedure exists [119]. The form of knowledge in the conceptual models is qualitative and the structure is hierarchical.

Hierarchical structure of the conceptual models is defined in the Skill-Rule-Knowledge (S-

R-K) perspective [87, 89, 90] (see Section 2.3). The models comprising either of levels of the S-R-K are qualitative in nature [99], correspond to decreasing level of familiarity with the task [92], and account for the trade off between the problem solving task and mental workload. In this chapter, a multi-level qualitative models for representing the objects, useful for reasoning and decision making within the S-R-K levels of behavior of humans is introduced.

2.2 Qualitative Reasoning: Background

Qualitative reasoning (QR) attempts to formalize common sense knowledge of the physical world, and reason with that knowledge [12, 45]. QR refers to the inferring and decision making methods by means of qualitative data and models. Qualitative data describes a physical change symbolically, mainly only by a three valued quantity space $(-,0,+)$. A qualitative model is a set of expressions composed of qualitative variables and qualitative relations. Variables are either continuous and continuously differentiable functions of time (i.e. *reasonable variables* [71]), or discrete with an ordered set of landmark values [83, 118]. Qualitative relations represent trends or functional relations (e.g. monotonic increase, decrease, etc.), ordering relations (e.g. bigger, smaller, etc.) and dependencies (e.g. influences [45]). Qualitative models provide the basis for simulation and reasoning [12]. Qualitative simulation (QS) uses a qualitative model and qualitative causal calculus to simulate and interpret the behavior of physical systems [28, 45, 71, 83, 17] (see Figure 2.5).

QR has to be elaborated significantly to be fully utilized in complex tasks such as planning and fault diagnosis [106]. Some extension issues are: qualitative interpretation of the sensory data; generating and testing new hypotheses; incorporating synchronization and time in the qualitative model; and learning experienced procedures. In qualitative interpretation, a finite set of reference patterns are recognized within the data. Methods for qualitative interpretation of a closed and temporally ordered set of numerical data have already been introduced [47]. In hypothesis generation and test the assumption based truth maintenance (ATMS) has been widely used to test hypotheses [29] and extended it to account for hierarchies and multiple tests [112]. The ways of extending qualitative models to include synchronization and timing of events and learning diagnostic procedures by qualitative sensitivity analysis are issues discussed in this report [36, 39].

2.3 Conceptual Models: Background

Conceptual models account for human understanding capabilities [7], reflecting how objects in the external world interact and behave [94]. The Skill-Rule-Knowledge (S-R-K) framework [87, 89, 90], is a unified view of various levels of human problem solving (see Figure 2.5).

In the S-R-K perspective, skill based level denotes almost routine performance. In this level, human performance is governed by stored patterns of predefined instructions [92]. Such

context specific patterns are called *rules-of-thumb* (or symptomatic rules), that map directly from an observation to a hypothesis. We introduce a method for systematic generation of such rules. Rule based level represents more conscious behavior when handling familiar problems. Rule based behavior is conventionally described by decision tables, digraphs, fuzzy sets and natural language models [66]. The model for this level is a set of stored rules. We introduce the Qualitative Compiled Model (QC_M) and Qualitative Sensitivity Analysis (QS_A) [36], as the modeling and reasoning techniques for this level. Knowledge based level accounts for tasks for which common patterns in stored knowledge form do not exist and reasoning should start from the so called *first principles*. Qualitative Deep Model (QD_M), methods for soliciting candidate faults, concurrent fault hypothesis validation and assessment of the situation, systematically explore different aspects of this level.

A distinguished feature of reasoning with conceptual models is their strength when applied to making statements about trends of change, causal dependencies, and ordering of events within a certain level of abstraction. Qualitative Simulation (QS) is a way of deriving behavior and functions from the model within a certain level. However, poor performance may be achieved when the conceptual models are used to manipulate numerical data or reasoning when shifting among the levels. Qualitative reasoning and simulation techniques are required to have the capability of handling the latter (see Chapter 4).

2.4 Qualitative Deep Model

QD_M is composed of a set of expressions involving three primitives: *qualitative variables* and two types of *qualitative operations*. Qualitative variables are counterpart of physical quantities, such as temperature and pressure, representing characteristics of the system's inner environment. Variables are measurable and have a defined domain of variation. A qualitative variable (shown by $[X]$, $[Y]$, etc.) has a finite ordered set of paired landmark values and distinguished time points. They are displayed in the form of a graph or a finite sequence of pairs (L^k, T^k) ,

$$(L_X^0, T_X^0), (L_X^1, T_X^1), \dots, (L_X^n, T_X^n) \quad (2.1)$$

Where L_X^k and T_X^k are the kth landmark value and distinguished time point of variable $[X]$.

Relation between the qualitative variables is defined by qualitative operations. There are two types of operations: *ordinary* and *coordinative*. Ordinary operations show a *functionality* or an *influence* on a qualitative variable. The functions are monotonic increase (M^+) and monotonic decrease (M^-) [71]. Influence is a proportionality to the derivative of a qualitative variable. The influences are positive influence (I^+) and negative influence (I^-) [45].

Coordinative operations model the protocol based relations and timing. We have found them necessary because first, in many man made systems the relation between components (and their corresponding models) are governed by defined protocols rather than pure physical laws.

Secondly, coordinative operations depict the relative timing of qualitative variables and when they get to a new landmark value without necessarily recording all the distinguished time points.

Definition 2.4.1 (Qualitative Deep Model) *Qualitative deep model is a set of expressions of the following form:*

$$[Y] = O[X] \text{ 'D' } [N] \quad (2.2)$$

$[Y]$, $[X]$ and $[N]$ are qualitative variables;

O is an ordinary qualitative operation. $O \in \mathcal{O}$,

$\mathcal{O} = \{M^+, M^-, I^+, I^-\}$

'D' is a coordinative operation ('when', 'until' and 'default'),

- 'when' operation: $[Y] = O[X]$ 'when' ($[N]$ is evaluated to L_N^i); implying that $[Y] = O[X]$ only when $[N]$ is evaluated to its landmark value L_N^i .
- 'until' operation: $[Y] = O[X]$ 'until' ($[N]$ is evaluated to L_N^i); implying that $[Y] = O[X]$ before $[N]$ is evaluated to its landmark value L_N^i .
- 'default' operation: $[Y] = O[X]$ 'default' $O[Z]$; implying that generally $[Y] = O[X]$, but in special cases that $[X]$ is not present, then $[Y] = O[Z]$.

Y, X and N are qualitative variables; L_N^i is the i th landmark value of N .

In special cases $[N]$ is a variable with two landmark values evaluated to *true* or *false*.

For each coordinative operation *clock* and *dependency* constraints are defined [10]. Clock and dependency constraints can only be evaluated to one of the followings represented by mod-3 integers [10]:

- *present* (± 1): indicating that two events can occur concurrently;
- *absent* (0): indicating that two events cannot occur concurrently;
- *true* (+1): indicating that an event has occurred;
- *false* (-1): indicating that an event has not occurred.

Table 2.1 depicts the clock and dependency constraints for coordinative operations.

The modeling technique is explained with a simplified plant, shown in Figure 2.5. In this system, there is a uniform supply of material to T_2 through CV_6 . The pressure in T_2 is controlled by the settings of CV_4 and CV_5 . The overall amount of the two phase material (denoted by material A and B) in T_2 is controlled by CV_1 and CV_2 . The pressure in T_1 is controlled by CV_4 . The level of material A in T_1 is controlled by CV_1 and CV_3 . QD_M for this system is given below.

A controlled valve has a single state variable, Ω_{CV_i} , such that:

Table 2.1: Clock and dependency constraints for extended qualitative expressions.

QD _M expression	Clock Constraint	Dependency Constraint
$[Y] = O[X] \pm O[Z]$	$y^2 = x^2 = z^2$	$y^2 : [X] \longrightarrow O \longrightarrow [Y]$ $y^2 : [Z] \longrightarrow O \longrightarrow [Y]$
$[Y] = O[X]$ 'when' (L_N^i)	$y^2 = x^2(-n - n^2)$	$y^2 : [X] \longrightarrow O \longrightarrow [Y]$
$[Y] = O[X]$ 'until' (L_N^i)	$y^2 = x^2(-n)$	$y^2 : [X] \longrightarrow O \longrightarrow [Y]$
$[Y] = O[X]$ 'default' ($O[Z]$)	$y^2 = x^2 + z^2(1 - x^2)$	$x^2 : [X] \longrightarrow O \longrightarrow [Y]$ $z^2(1 - x^2) : [Z] \longrightarrow O \longrightarrow [Y]$

X, Y, Z and N are qualitative variables. x, y, z and n are their mod-3 values (-1, 0, +1), respectively. L_N^i is the ith landmark value of the variable N.

$\forall CV_i,$

$(\Omega_{CV_i} > 0)$: valve enabled;

$(\Omega_{CV_i} = 0)$: valve disabled;

Concerning the tanks, there is a uniform supply of material to T_2 through CV_6 . Pressure of T_2 is controlled by CV_4 and CV_5 . Overall level of the two phase material (material A and B) in T_2 is controlled by CV_1 and CV_2 . Pressure of T_1 is controlled by CV_4 . Level of the material in T_1 is controlled by CV_1 and CV_3 .

Qualitative variables are: $F_1, G_1, U_1, K_1, U_2, K_2, F_2, G_2, J_1, N_1, S_1$ and E_1 , representing flow-in and flow-out for the controlled valves CV_1 – CV_6 , respectively; $\Omega_{CV_1}, \Omega_{CV_2}, \Omega_{CV_3}, \Omega_{CV_4}, \Omega_{CV_5}$, and Ω_{CV_6} are state variables of the valves; P_{T_2} and P_{T_1} are net pressure of T_2 and T_1 ; P_1 and P_2 are pressure losses of T_2 ; F_{in/T_2} and F_{in/T_1} are flow of material into T_2 and T_1 ; H_{T_2} and H_{T_1} are overall level of material in T_2 and T_1 ; H_{A/T_2} and H_{B/T_2} are level of material of type A and B in T_2 ; F_{out/T_2} and A_{out/T_2} are flow of material and air out of T_2 ; F_{T_1} and A_{in/T_1} are net flow of material and air into T_1 ;

$$\begin{aligned}
 [F_1] = [G_1] &= M^+[\Omega_{CV_1}] \text{ 'when' } (\Omega_{CV_1} > 0) \\
 [U_1] = [K_1] &= M^+[\Omega_{CV_2}] \text{ 'when' } (\Omega_{CV_2} > 0) \\
 [U_2] = [K_2] &= M^+[\Omega_{CV_3}] \text{ 'when' } (\Omega_{CV_3} > 0) \\
 [F_2] = [G_2] &= M^+[\Omega_{CV_4}] \text{ 'when' } (\Omega_{CV_4} > 0) \\
 [J_1] = [N_1] &= M^+[\Omega_{CV_5}] \text{ 'when' } (\Omega_{CV_5} > 0) \\
 [S_1] = [E_1] &= M^+[\Omega_{CV_6}] \text{ 'when' } (\Omega_{CV_6} > 0)
 \end{aligned}$$

$$\begin{aligned}
 [P_1] &= I^-[G_2] && \text{'when'} \quad (\Omega_{CV_4} > 0) \\
 [P_2] &= I^-[N_1] && \text{'when'} \quad (\Omega_{CV_5} > 0) \\
 [F_{in/T_2}] &= M^+[E_1] && \text{'when'} \quad (\Omega_{CV_6} > 0) \\
 [H_{A/T_2}] &= I^-[G_1] && \text{'when'} \quad (\Omega_{CV_1} > 0) \\
 [H_{B/T_2}] &= I^-[U_1] && \text{'when'} \quad (\Omega_{CV_2} > 0) \\
 [P_{T_1}] &= I^+[G_2] && \text{'when'} \quad (\Omega_{CV_4} > 0) \\
 [F_{in/T_1}] &= M^+[G_1] && \text{'when'} \quad (\Omega_{CV_1} > 0) \\
 [F_{out/T_1}] &= M^+[U_2] && \text{'when'} \quad (\Omega_{CV_3} > 0) \\
 [P_{T_2}] &= M^+[P_1] &+ & M^+[P_2] \\
 [H_{T_2}] &= M^+[H_{A/T_2}] &+ & M^+[H_{B/T_2}] \\
 [F_{T_1}] &= M^+[F_{in/T_1}] &+ & M^-[F_{out/T_1}] \\
 [F_{out/T_2}] &= I^+[U_1] &+ & I^+[F_1] \\
 [A_{out/T_2}] &= I^+[N_1] &+ & I^+[F_2] \\
 [H_{T_1}] &= I^+[F_{T_1}] \\
 [H_{T_2}] &= I^+[F_{in/T_2}] \\
 [A_{in/T_1}] &= I^+[G_2]
 \end{aligned}$$

Clock constraints:

$$\begin{aligned}
 f_1^2 &= g_1^2 = \omega_{CV_1}^2(-\omega_{CV_1} - \omega_{CV_1}^2) \\
 u_1^2 &= k_1^2 = \omega_{CV_2}^2(-\omega_{CV_2} - \omega_{CV_2}^2) \\
 u_2^2 &= k_2^2 = \omega_{CV_3}^2(-\omega_{CV_3} - \omega_{CV_3}^2) \\
 f_2^2 &= g_2^2 = \omega_{CV_4}^2(-\omega_{CV_4} - \omega_{CV_4}^2) \\
 j_1^2 &= n_1^2 = \omega_{CV_5}^2(-\omega_{CV_5} - \omega_{CV_5}^2) \\
 s_1^2 &= e_1^2 = \omega_{CV_6}^2(-\omega_{CV_6} - \omega_{CV_6}^2) \\
 p_1^2 &= g_2^2(-\omega_{CV_4} - \omega_{CV_4}^2) \\
 p_2^2 &= n_1^2(-\omega_{CV_5} - \omega_{CV_5}^2) \\
 f_{in/T_2}^2 &= e_1^2(-\omega_{CV_6} - \omega_{CV_6}^2) \\
 h_{A/T_2}^2 &= g_1^2(-\omega_{CV_1} - \omega_{CV_1}^2) \\
 h_{B/T_2}^2 &= u_1^2(-\omega_{CV_2} - \omega_{CV_2}^2) \\
 p_{T_1}^2 &= g_2^2(-\omega_{CV_4} - \omega_{CV_4}^2) \\
 f_{in/T_1}^2 &= g_1^2(-\omega_{CV_1} - \omega_{CV_1}^2) \\
 f_{out/T_1}^2 &= u_2^2(-\omega_{CV_3} - \omega_{CV_3}^2) \\
 p_{T_2}^2 &= p_1^2 = p_2^2 \\
 h_{T_2}^2 &= h_{A/T_2}^2 = h_{B/T_2}^2 \\
 f_{T_1}^2 &= f_{in/T_1}^2 = f_{out/T_1}^2
 \end{aligned}$$

$$\begin{aligned}
f_{out/T_2}^2 &= u_1^2 = f_1^2 \\
a_{out/T_2}^2 &= n_1^2 = f_2^2 \\
h_{T_1}^2 &= f_{T_1}^2 \\
h_{T_2}^2 &= f_{in/T_2}^2 \\
a_{in/T_1}^2 &= g_2^2
\end{aligned}$$

Dependency constraints:

$$\begin{aligned}
\omega_{CV_1}^2 &: [\Omega_{CV_1}] \longrightarrow M^+ \longrightarrow [G_1] \\
\omega_{CV_2}^2 &: [\Omega_{CV_2}] \longrightarrow M^+ \longrightarrow [U_1] \\
\omega_{CV_3}^2 &: [\Omega_{CV_3}] \longrightarrow M^+ \longrightarrow [U_2] \\
\omega_{CV_4}^2 &: [\Omega_{CV_4}] \longrightarrow M^+ \longrightarrow [G_2] \\
\omega_{CV_5}^2 &: [\Omega_{CV_5}] \longrightarrow M^+ \longrightarrow [N_1] \\
\omega_{CV_6}^2 &: [\Omega_{CV_6}] \longrightarrow M^+ \longrightarrow [E_1] \\
\omega_{CV_4}^2(-\omega_{CV_4} - \omega_{CV_4}^2) &: [G_2] \longrightarrow I^- \longrightarrow [P_1] \\
\omega_{CV_5}^2(-\omega_{CV_5} - \omega_{CV_5}^2) &: [N_1] \longrightarrow I^- \longrightarrow [P_2] \\
\omega_{CV_6}^2(-\omega_{CV_6} - \omega_{CV_6}^2) &: [E_1] \longrightarrow M^+ \longrightarrow [F_{in/T_2}] \\
\omega_{CV_1}^2(-\omega_{CV_1} - \omega_{CV_1}^2) &: [G_1] \longrightarrow I^- \longrightarrow [H_{A/T_2}] \\
\omega_{CV_2}^2(-\omega_{CV_2} - \omega_{CV_2}^2) &: [U_1] \longrightarrow I^- \longrightarrow [H_{B/T_2}] \\
\omega_{CV_4}^2(-\omega_{CV_4} - \omega_{CV_4}^2) &: [G_2] \longrightarrow I^+ \longrightarrow [P_{T_1}] \\
\omega_{CV_1}^2(-\omega_{CV_1} - \omega_{CV_1}^2) &: [G_1] \longrightarrow M^+ \longrightarrow [F_{in/T_1}] \\
\omega_{CV_3}^2(-\omega_{CV_3} - \omega_{CV_3}^2) &: [U_2] \longrightarrow M^+ \longrightarrow [F_{out/T_1}]
\end{aligned}$$

2.4.1 Qualitative Flow Graph

QD_M cannot show explicitly indirect influences of variables and how perturbation can be propagated through the model. For such cases graph representation has been found useful [123]. Formally, we define Qualitative Flow Graph (QFG) as a digraph embodying the QD_M expressions. In QFG , nodes are qualitative variables and arcs are conditional ordinary qualitative operations, whose antecedents are ‘dependency constraints’.

Definition 2.4.2 (Qualitative Flow Graph) QFG is a digraph represented by 4 sets:

$$QFG = \{\mathcal{V}, \mathcal{A}, \mathcal{O}, \mathcal{C}\} \quad (2.3)$$

\mathcal{V} set of nodes standing for the qualitative variables; \mathcal{A} set of arcs relating the two nodes; \mathcal{O} set of ordinary qualitative operations; \mathcal{C} set of dependency constraints for coordinative qualitative operations given in Table 2.1;

All the arcs of the QFG are conditional. A conditional arc is:

$$A : C \rightarrow O \quad (2.4)$$

For each arc, $A \in \mathcal{A}$, if for $C \in \mathcal{C}$, $\mathcal{E}(C) = 1$ holds, then $O \in \mathcal{O}$ is enabled.
 $\mathcal{E}(C)$ is an evaluation of the constraint C .

QFG for the example system is shown in Figure 2.5.

2.4.2 Qualitative Processes

QFG is a network of overlapping qualitative processes. A qualitative process (QP) is a finite, connected, unidirectional string of arcs of QFG , relating an input node to an output one. An input node is the one with an in-degree zero. Similarly, an output node is the one with an out-degree zero. Thus a process shows how qualitative variables can affect each other¹. Qualitative processes are extracted from the QFG by *decomposition*, i.e. assigning the shared nodes and arcs between two processes to both of them. There are 16 processes for the tank system given below. For each conditional arc, the antecedent is written above the consequence which is an ordinary qualitative operation.

$$\begin{aligned}
 P_1 : & \boxed{\Omega_{CV_3}} \xrightarrow{\omega_{CV_3}^2} \boxed{M^+} \rightarrow \boxed{U_2} \rightarrow \boxed{K_2} \rightarrow \text{to other subsystems} \\
 P_2 : & \boxed{\Omega_{CV_3}} \xrightarrow{\omega_{CV_3}^2} \boxed{M^+} \rightarrow \boxed{U_2} \xrightarrow{\omega_{CV_3}^2 (-\omega_{CV_3} - \omega_{CV_3}^2)} \boxed{M^+} \rightarrow \boxed{F_{out/T_1}} \xrightarrow{M^-} \boxed{F_{T_1}} \xrightarrow{I^+} \boxed{H_{T_1}} \\
 P_3 : & \boxed{\Omega_{CV_1}} \xrightarrow{\omega_{CV_1}^2} \boxed{M^+} \rightarrow \boxed{G_1} \xrightarrow{\omega_{CV_1}^2 (-\omega_{CV_1} - \omega_{CV_1}^2)} \boxed{M^+} \rightarrow \boxed{F_{in/T_1}} \xrightarrow{M^+} \boxed{F_{T_1}} \xrightarrow{I^+} \boxed{H_{T_1}} \\
 P_4 : & \boxed{\Omega_{CV_1}} \xrightarrow{\omega_{CV_1}^2} \boxed{M^+} \rightarrow \boxed{G_1} \xrightarrow{\omega_{CV_1}^2 (-\omega_{CV_1} - \omega_{CV_1}^2)} \boxed{I^-} \rightarrow \boxed{H_{A/T_2}} \xrightarrow{M^+} \boxed{H_{T_2}} \\
 P_5 : & \boxed{\Omega_{CV_1}} \xrightarrow{\omega_{CV_1}^2} \boxed{M^+} \rightarrow \boxed{G_1} \xrightarrow{M^+} \boxed{F_1} \xrightarrow{I^+} \boxed{F_{out/T_2}} \\
 P_6 : & \boxed{\Omega_{CV_2}} \xrightarrow{\omega_{CV_2}^2} \boxed{M^+} \rightarrow \boxed{U_1} \xrightarrow{I^+} \boxed{F_{out/T_2}}
 \end{aligned}$$

¹ similar to the definition of process in system engineering, cf. [64].

$$\begin{aligned}
 P_7 : & \boxed{\Omega_{CV_2}} \xrightarrow{\omega_{CV_2}^2} \boxed{U_1} \xrightarrow{\omega_{CV_2}^2 (-\omega_{CV_2} - \omega_{CV_2}^2)} \boxed{H_{B/T_2}} \xrightarrow{M^+} \boxed{H_{T_2}} \\
 P_8 : & \boxed{\Omega_{CV_2}} \xrightarrow{\omega_{CV_2}^2} \boxed{U_1} \longrightarrow \boxed{K_1} \longrightarrow \text{to other subsystems} \\
 P_9 : & \boxed{\Omega_{CV_6}} \xrightarrow{\omega_{CV_6}^2} \boxed{E_1} \xrightarrow{\omega_{CV_6}^2 (-\omega_{CV_6} - \omega_{CV_6}^2)} \boxed{F_{in/T_2}} \xrightarrow{I^+} \boxed{H_{T_2}} \\
 P_{10} : & \boxed{\Omega_{CV_4}} \xrightarrow{\omega_{CV_4}^2} \boxed{G_2} \xrightarrow{\omega_{CV_4}^2 (-\omega_{CV_4} - \omega_{CV_4}^2)} \boxed{P_{T_1}} \\
 P_{11} : & \boxed{\Omega_{CV_4}} \xrightarrow{\omega_{CV_4}^2} \boxed{G_2} \xrightarrow{I^+} \boxed{A_{in/T_1}} \\
 P_{12} : & \boxed{\Omega_{CV_4}} \xrightarrow{\omega_{CV_4}^2} \boxed{G_2} \xrightarrow{I^+} \boxed{A_{out/T_2}} \\
 P_{13} : & \boxed{\Omega_{CV_4}} \xrightarrow{\omega_{CV_4}^2} \boxed{G_2} \xrightarrow{\omega_{CV_4}^2 (-\omega_{CV_4} - \omega_{CV_4}^2)} \boxed{P_1} \xrightarrow{M^+} \boxed{P_{T_2}} \\
 P_{14} : & \boxed{\Omega_{CV_5}} \xrightarrow{\omega_{CV_5}^2} \boxed{N_1} \xrightarrow{\omega_{CV_5}^2 (-\omega_{CV_5} - \omega_{CV_5}^2)} \boxed{P_2} \xrightarrow{M^+} \boxed{P_{T_2}} \\
 P_{15} : & \boxed{\Omega_{CV_5}} \xrightarrow{\omega_{CV_5}^2} \boxed{N_1} \xrightarrow{I^+} \boxed{A_{out/T_2}} \\
 P_{16} : & \boxed{\Omega_{CV_5}} \xrightarrow{\omega_{CV_5}^2} \boxed{N_1} \longrightarrow \boxed{J_1} \longrightarrow \text{to other subsystems}
 \end{aligned}$$

The notion of process has acquired different meanings in qualitative reasoning literature². A key point is distinguishing the effects of a perturbation on the network of the overlapping processes. By exploiting the conventional definition of process and qualitative simulation, a number of possible behaviors are generated and a one to one relation between an observation and a characteristic behavior of the system cannot be established. For the sake of removing the ambiguity in simulation, the network of overlapping processes is decomposed and the characteristic behavior for each process is derived. Such behavioral information are found useful in learning and fault diagnosis (see Chapter 4).

2.4.3 Behavioral Fragments

Behavioral fragment (BF) is the characteristic behavior of a process and is defined as the record of landmark values for the displayed³ qualitative variables belonging to that process.

² Weld has defined continuous and discrete processes by two sets of preconditions and influences [117]. Preconditions govern when the process can be active and influences show how various quantities are modified through an active process. In Forbus' terms a qualitative process is specified by five parts: individuals, preconditions, quantity conditions, relations and influences [45].

³ i.e. those variables considered important to be tracked or recorded.

Definition 2.4.3 (Behavioral Fragment) Behavioral fragment BF_{P_j} of a process P_j , is a finite sequence of landmark values (L_V^k) , of the form:

$$BF_{P_j} = \{\forall V \in P_j \mid (L_V^0, L_V^1, \dots, L_V^n)\} \quad (2.5)$$

$$BF_{P_j} = \{\forall v \in P_j \mid \biguplus_{k=0}^n (L_V^k)\} \quad (2.6)$$

L_V^k is the k th landmark value of a displayed qualitative variable V ; and \biguplus is a symbol for abbreviating (2.5) to (2.6).

BFs are derived by qualitative simulation (QS) in two steps:

- Dependency constraint satisfaction on the arcs of the processes.
- Landmark value identification of the qualitative variables.

First, the simulator looks for the antecedents of the conditional arcs that can satisfy the given situation. Through clock and dependency analysis one can verify which of the arcs of the processes are activated and can take part in simulation. Then processes whose enabling conditions of their arcs are not yet satisfied are deleted. On the next step, a conventional simulation program derives landmark values for each variable of the remaining processes.

For the processes of the tank example, and for the displayed qualitative variables the BFs are given below.

$$\begin{aligned}
 BF_{P_1} &= [\Omega_{CV_3} : 0, (\Omega_{CV_3} > 0)], [U_2 : 0, (U_2 > 0)], [K_2 : 0, (K_2 > 0)] \\
 BF_{P_2} &= [\Omega_{CV_3} : 0, (\Omega_{CV_3} > 0)], [U_2 : 0, (U_2 > 0)], [F_{T_1} : 0, (F_{T_1} < 0)], \\
 &\quad [H_{T_1} : H_{T_1}^o, (H_{(T_1)min} \leq H_{T_1} < H_{T_1}^o)] \\
 BF_{P_3} &= [\Omega_{CV_1} : 0, (\Omega_{CV_1} > 0)], [G_1 : 0, (G_1 > 0)], [F_{T_1} : 0, (F_{T_1} > 0)], \\
 &\quad [H_{T_1} : H_{T_1}^o, (H_{T_1}^o < H_{T_1} \leq H_{(T_1)max})] \\
 BF_{P_4} &= [\Omega_{CV_1} : 0, (\Omega_{CV_1} > 0)], [G_1 : 0, (G_1 > 0)], \\
 &\quad [H_{T_2} : H_{T_2}^o, (H_{(T_2)min} \leq H_{T_2} < H_{T_2}^o)] \\
 BF_{P_5} &= [\Omega_{CV_1} : 0, (\Omega_{CV_1} > 0)], [F_1 : 0, (F_1 > 0)], \\
 &\quad [F_{out/T_2} : 0, (0 < F_{out/T_2} \leq F_{(out/T_2)max})] \\
 BF_{P_6} &= [\Omega_{CV_2} : 0, (\Omega_{CV_2} > 0)], [U_1 : 0, (U_1 > 0)], \\
 &\quad [F_{out/T_2} : 0, (0 < F_{out/T_2} \leq F_{(out/T_2)max})] \\
 BF_{P_7} &= [\Omega_{CV_2} : 0, (\Omega_{CV_2} > 0)], [U_1 : 0, (U_1 > 0)], \\
 &\quad [H_{T_2} : H_{T_2}^o, (H_{(T_2)min} \leq H_{T_2} < H_{T_2}^o)] \\
 BF_{P_8} &= [\Omega_{CV_2} : 0, (\Omega_{CV_2} > 0)], [U_1 : 0, (U_1 > 0)], [K_1 : 0, (K_1 > 0)]
 \end{aligned}$$

$$\begin{aligned}
BF_{P_9} &= [\Omega_{CV_6} : 0, (\Omega_{CV_6} > 0)], [E_1 : 0, (E_1 > 0)], \\
&\quad [H_{T_2} : H_{T_2}^o, (H_{T_2}^o < H_{T_2} \leq H_{(T_2)max})] \\
BF_{P_{10}} &= [\Omega_{CV_4} : 0, (\Omega_{CV_4} > 0)], [G_2 : 0, (G_2 > 0)], \\
&\quad [P_{T_1} : P_{T_1}^o, (P_{T_1}^o < P_{T_1} \leq P_{(T_1)max})] \\
BF_{P_{11}} &= [\Omega_{CV_4} : 0, (\Omega_{CV_4} > 0)], [G_2 : 0, (G_2 > 0)], \\
&\quad [A_{in/T_1} : 0, (0 < A_{in/T_1} \leq A_{(in/T_1)max})] \\
BF_{P_{12}} &= [\Omega_{CV_4} : 0, (\Omega_{CV_4} > 0)], [G_2 : 0, (G_2 > 0)], \\
&\quad [A_{out/T_2} : 0, (0 < A_{out/T_2} \leq A_{(out/T_2)max})] \\
BF_{P_{13}} &= [\Omega_{CV_4} : 0, (\Omega_{CV_4} > 0)], [G_2 : 0, (G_2 > 0)], \\
&\quad [P_{T_2} : P_{T_2}^o, (P_{(T_2)min} \leq P_{T_2} < P_{T_2}^o)] \\
BF_{P_{14}} &= [\Omega_{CV_5} : 0, (\Omega_{CV_5} > 0)], [N_1 : 0, (N_1 > 0)], \\
&\quad [P_{T_2} : P_{T_2}^o, (P_{(T_2)min} \leq P_{T_2} < P_{T_2}^o)] \\
BF_{P_{15}} &= [\Omega_{CV_5} : 0, (\Omega_{CV_5} > 0)], [N_1 : 0, (N_1 > 0)], \\
&\quad [A_{out/T_2} : 0, (0 < A_{out/T_2} \leq A_{(out/T_2)max})] \\
BF_{P_{16}} &= [\Omega_{CV_5} : 0, (\Omega_{CV_5} > 0)], [N_1 : 0, (N_1 > 0)], [J_1 : 0, (J_1 > 0)]
\end{aligned}$$

2.5 Qualitative Compiled Model

QC_M is the outcome of the goal seeking approach to modeling, in which the main principle of abstraction is identifying input/output relation between the modeling elements [74]. For each qualitative process two of the nodes are considerably important: the input node and the output node, standing for the input and output qualitative variables. Qualitative processes are lumped to a single arc ($A : C \rightarrow O$), that connects the input and output nodes. The antecedent C is derived by multiplying all the dependency constraints of the individual arcs of that process and the consequence O reveals the overall relation holding between the two end nodes of the process by combining the intermediate qualitative operations using the reduction rules given in Figure 2.5. Lumped processes for the example system are:

$$\begin{aligned}
P_1 &: [K_2] &= M^+[\Omega_{CV_3}] \\
P_2 &: [H_{T_1}] &= I^-[\Omega_{CV_3}] \\
P_3 &: [H_{T_1}] &= I^+[\Omega_{CV_1}] \\
P_4 &: [H_{T_2}] &= I^-[\Omega_{CV_1}] \\
P_5 &: [F_{out/T_2}] &= I^+[\Omega_{CV_1}] \\
P_6 &: [F_{out/T_2}] &= I^+[\Omega_{CV_2}] \\
P_7 &: [H_{T_2}] &= I^-[\Omega_{CV_2}] \\
P_8 &: [K_1] &= M^+[\Omega_{CV_2}] \\
P_9 &: [H_{T_2}] &= I^+[\Omega_{CV_6}] \\
P_{10} &: [P_{T_1}] &= I^+[\Omega_{CV_4}] \\
P_{11} &: [A_{in/T_1}] &= I^+[\Omega_{CV_4}] \\
P_{12} &: [A_{out/T_2}] &= I^+[\Omega_{CV_4}]
\end{aligned}$$

$$\begin{array}{lcl}
 P_{13} & : & [P_{T_2}] = I^-[\Omega_{CV_4}] \\
 P_{14} & : & [P_{T_2}] = I^-[\Omega_{CV_5}] \\
 P_{15} & : & [A_{out/T_2}] = I^+[\Omega_{CV_5}] \\
 P_{16} & : & [N_1] = M^+[\Omega_{CV_5}]
 \end{array}$$

A lumped process depicts the relation between landmark values of the input and output qualitative variables. Intuitively, if the overall operation M^+ or M^- holds between two qualitative variables $[X]$ and $[Y]$, namely, $[Y] = M^+[X]$ or $[Y] = M^-[X]$, one can derive that increase of the value of X will result an increase (or decrease) in Y , or on the other hand, steady X will produce steady Y . Therefore, a landmark value of $[X]$ is related to a landmark value of $[Y]$. In case of I^+ (or I^-), a steady X will produce a monotonically increasing (decreasing) Y , therefore there is a mapping from a landmark value of one to an interval bounded by two neighboring landmark values of the other. These are saved as single antecedent/single consequence *crude causal rules* in the ρ_{cc} set.

The relation between the antecedent and consequent of the crude causal rules denotes sufficient conditionality, i.e. validity of antecedent implies validity of consequence. The negative rules are assumed to be valid, that is, when an antecedent is not valid, the consequence is not valid, too. However, there is no strict implication, i.e. validity of a consequence does not necessarily lead to the validity of its antecedent. Therefore ρ_{cc} set includes both the causal rules as the result of lumping processes and their negations. Then antecedents of the crude rules having the same consequence are conjuncted to form a *Combinatory rule*. ρ_{com} is the set of combinatory rules, accounting for the overlapping processes. QCM is the union of the ρ_{cc} and ρ_{com} .

$$QCM = \rho_{cc} \cup \rho_{com} \quad (2.7)$$

Each QCM rule has the form,

$$\mathcal{R} : (p_i \wedge p_j \wedge \dots \rightarrow p_k) \quad (2.8)$$

(\wedge) is the logical connective ‘and’.

p_i, p_j and p_k are the antecedent and consequence propositions, addressing either a landmark value or an interval bounded by two neighboring landmark values of a qualitative variable. QCM rules for the pressure tank system are given below. QDM and QCM are used extensively in the following chapters.

- \mathcal{R}_1 : $(\Omega_{CV_3} > 0) \rightarrow (K_2 > 0)$
 \mathcal{R}_2 : $(\Omega_{CV_3} > 0) \wedge (\Omega_{CV_1} = 0) \rightarrow (H_{(T_1)min} \leq H_{T_1} < H_{T_1}^o)$
 \mathcal{R}_3 : $(\Omega_{CV_1} > 0) \wedge (\Omega_{CV_3} = 0) \rightarrow (H_{T_1}^o < H_{T_1} \leq H_{(T_1)max})$
 \mathcal{R}_4 : $(\Omega_{CV_1} > 0) \wedge (\Omega_{CV_2} > 0) \wedge (\Omega_{CV_6} = 0) \rightarrow (H_{(T_2)min} \leq H_{T_2} < H_{T_2}^o)$
 \mathcal{R}_5 : $(\Omega_{CV_1} > 0) \wedge (\Omega_{CV_2} > 0) \rightarrow (0 < F_{out/T_2} \leq F_{(out/T_2)max})$
 \mathcal{R}_6 : $(\Omega_{CV_2} > 0) \rightarrow (K_1 > 0)$
 \mathcal{R}_7 : $(\Omega_{CV_6} > 0) \wedge (\Omega_{CV_1} = 0) \wedge (\Omega_{CV_2} = 0) \rightarrow (H_{T_2}^o < H_{T_2} \leq H_{(T_2)max})$
 \mathcal{R}_8 : $(\Omega_{CV_4} > 0) \rightarrow (P_{T_1}^o < P_{T_1} \leq P_{(T_1)max})$
 \mathcal{R}_9 : $(\Omega_{CV_4} > 0) \wedge (\Omega_{CV_5} > 0) \rightarrow (0 < A_{out/T_2} \leq A_{(out/T_2)max})$
 \mathcal{R}_{10} : $(\Omega_{CV_4} > 0) \rightarrow (0 < A_{in/T_1} \leq A_{(in/T_1)max})$
 \mathcal{R}_{11} : $(\Omega_{CV_4} > 0) \wedge (\Omega_{CV_5} > 0) \rightarrow (P_{(T_2)min} \leq P_{T_2} < P_{T_2}^o)$
 \mathcal{R}_{12} : $(\Omega_{CV_5} > 0) \rightarrow (J_1 > 0)$
 \mathcal{R}_{13} : $(\Omega_{CV_3} = 0) \rightarrow (K_2 = 0)$
 \mathcal{R}_{14} : $(\Omega_{CV_1} = 0) \wedge (\Omega_{CV_2} = 0) \rightarrow (F_{out/T_2} = 0)$
 \mathcal{R}_{15} : $(\Omega_{CV_2} = 0) \rightarrow (K_1 = 0)$
 \mathcal{R}_{16} : $(\Omega_{CV_4} = 0) \rightarrow (P_{(T_1)min} \leq P_{T_1} < P_{T_1}^o)$
 \mathcal{R}_{17} : $(\Omega_{CV_4} = 0) \wedge (\Omega_{CV_5} = 0) \rightarrow (A_{out/T_2} = 0)$
 \mathcal{R}_{18} : $(\Omega_{CV_4} = 0) \rightarrow (A_{in/T_1} = 0)$
 \mathcal{R}_{19} : $(\Omega_{CV_4} = 0) \wedge (\Omega_{CV_5} = 0) \rightarrow (P_{T_2}^o < P_{T_2} \leq P_{(T_2)max})$
 \mathcal{R}_{20} : $(\Omega_{CV_5} = 0) \rightarrow (J_1 = 0)$

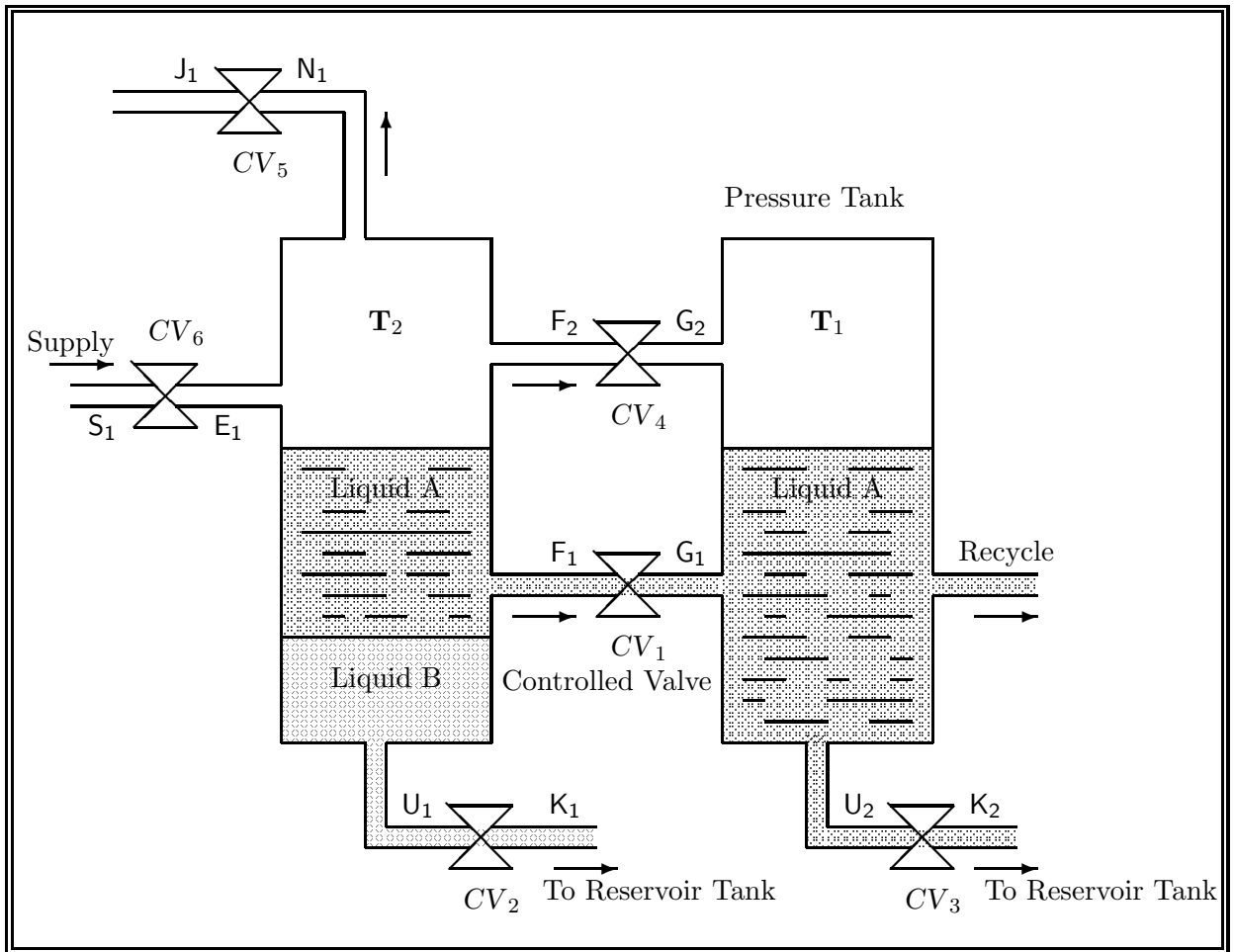

Figure 2.1: Double pressure tank system.

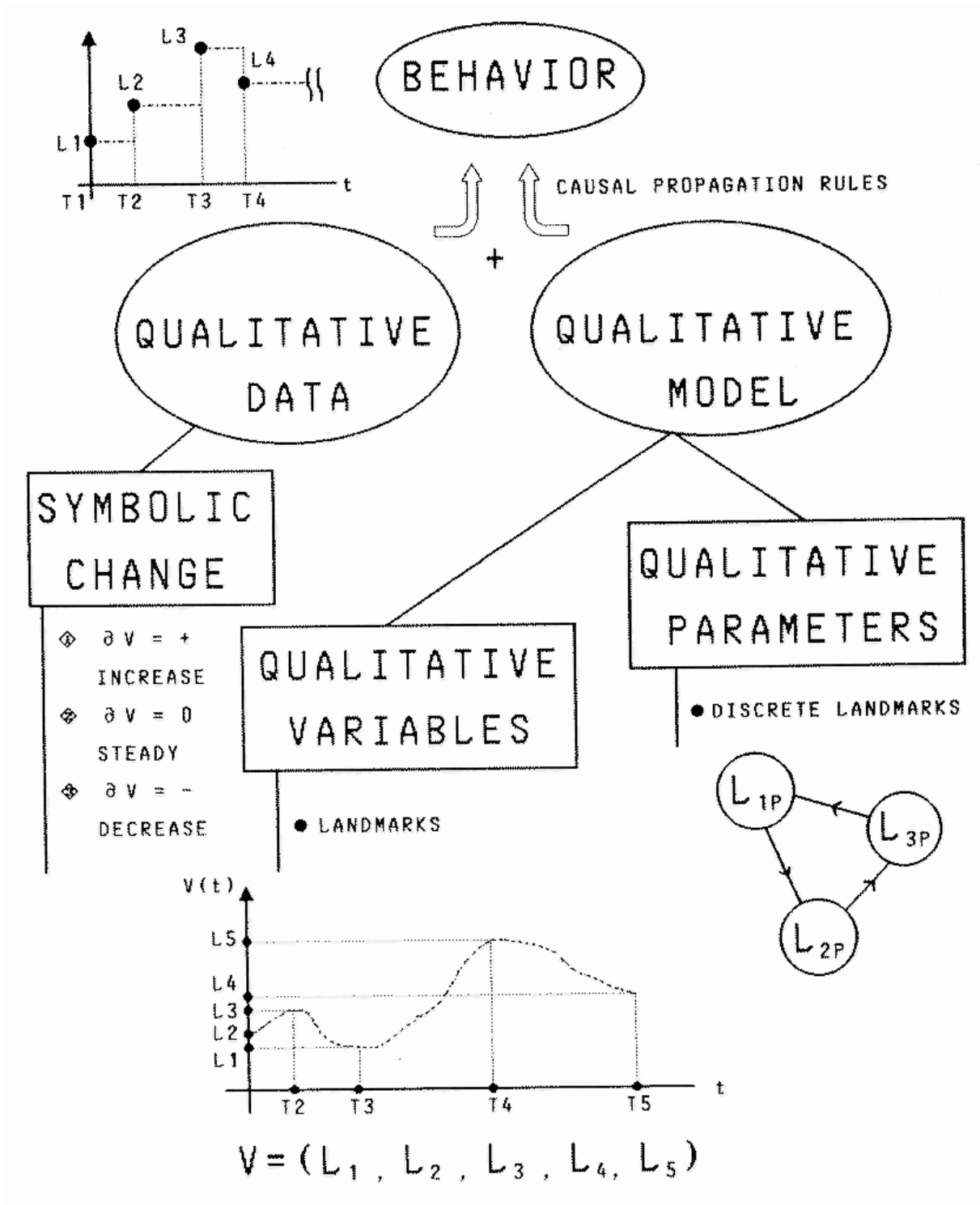

Figure 2.2: Qualitative modeling and reasoning.

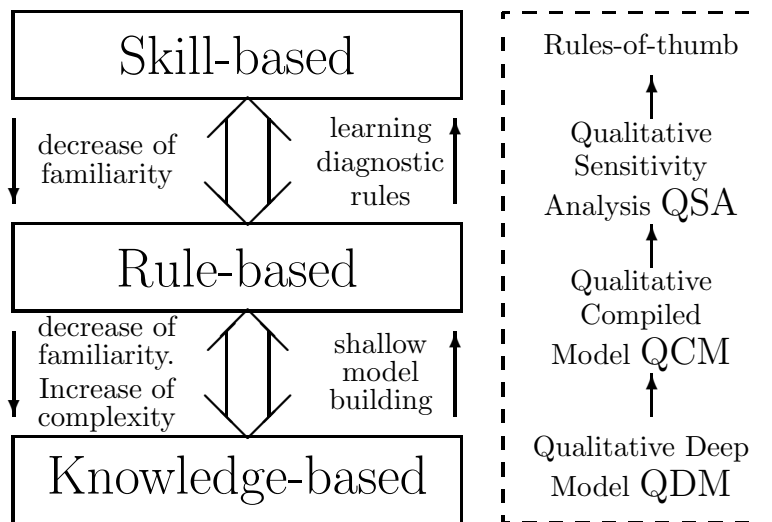

Figure 2.3: Hierarchical model of human behavior along with the associated modeling and reasoning techniques.

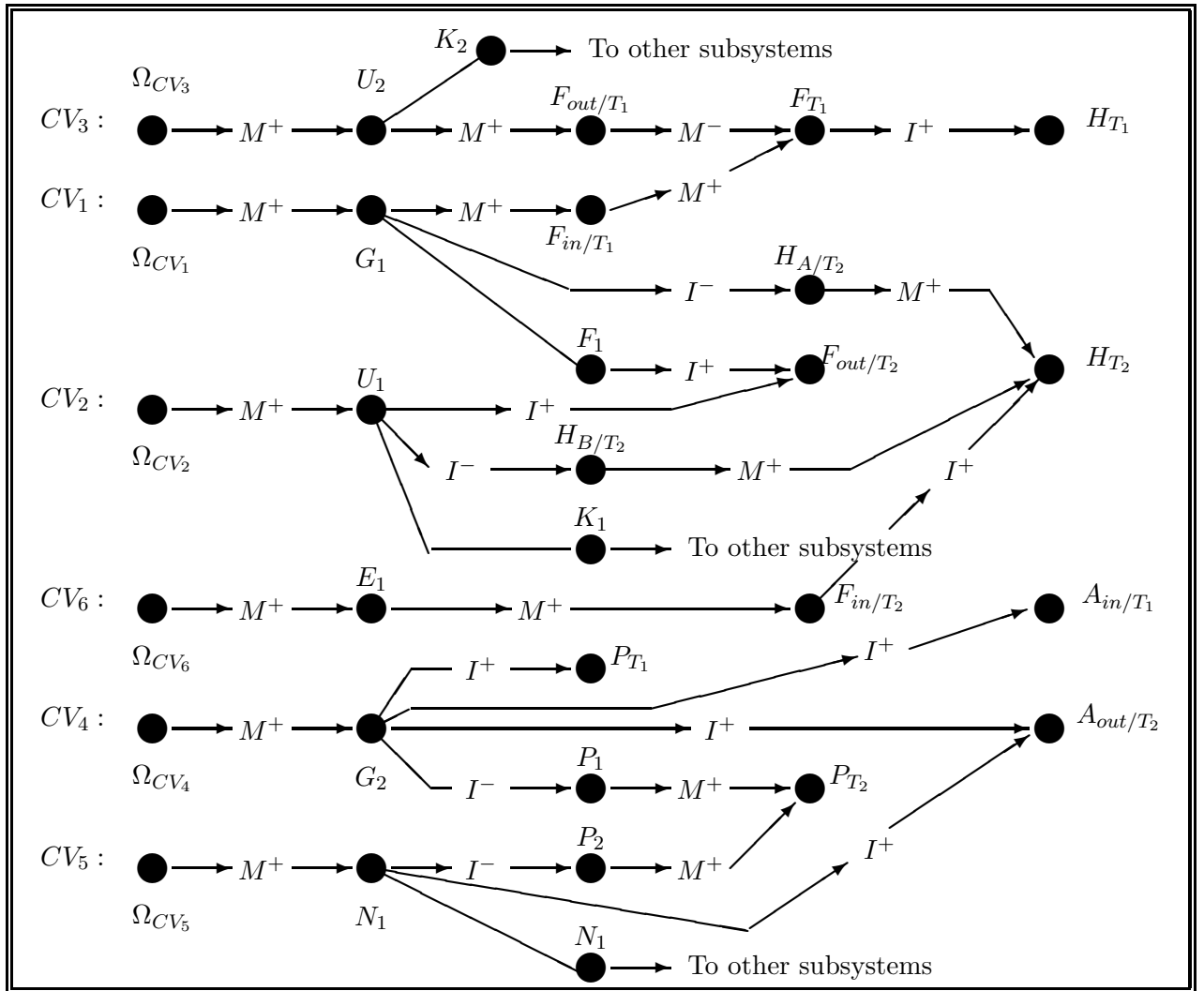

Figure 2.4: Qualitative flow graph for the pressure tank system.

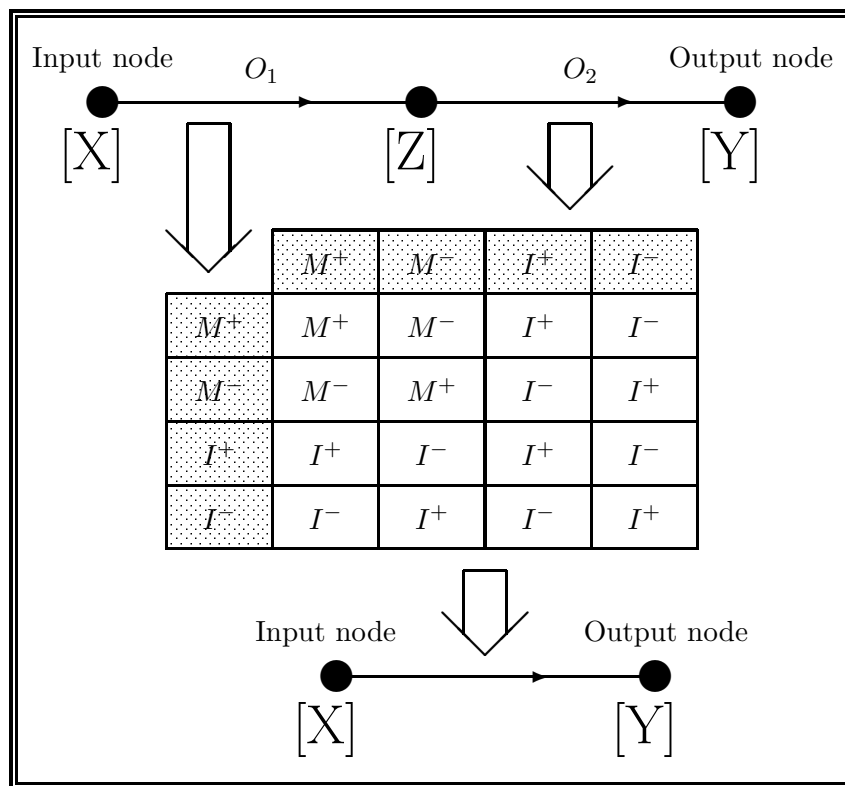

Figure 2.5: Reduction rules for lumped processes.

Chapter 3

Research on Model Based Learning: A Model Based Learning Technique for Generating Shallow Rules-of-Thumb from Deep Qualitative Model

3.1 Introduction

The ability to learn and use its outcomes to improve the behavior is integral to human intelligence. *Skill learning*, i.e. efficient utilization of the experiences gained from a comprehensive analysis of the plant, is a necessity [42, 43]. When performing routine tasks in defined domains the same or similar symptoms may happen frequently. Learning problem solving procedures and augmentation or refinement of the knowledge, when dealing with similar cases, are important issues [1].

There are three stages of skill learning: *autonomous*, *associative* and *cognitive*, as counterparts of the S-R-K levels, respectively [99]. Among the learning paradigms, model-based learning suits best for acquiring rules for expert systems in well-structured knowledge-rich domains that require deep reasoning and multi-step inference, even if few training examples are available [20]. In this sense, knowledge acquisition for associative and cognitive learning addresses transition between the levels of the conceptual model. For instance, acquiring the deep qualitative model, generating compiled model from the deep qualitative model and generating rule-of-thumb from the compiled model.

This chapter introduces a model-based learning technique using Qualitative Sensitivity Analysis [36]. *QA* offers an effective way of acquiring the experience gained in problem solving by a comprehensive analysis of a deep qualitative model, and using the results for augmentation and refinement of the expertise embedded in the form of shallow rules-of-thumb. The generated rules are explainable in terms of the deep model, more accurate and reliable than heuristic

based rules in conventional expert systems. Applications of QSA to the model-based discourse understanding is also reported. Figure 3.4 depicts the structure of the qualitative sensitivity analyzer.

In this approach, QD_M is given and the QC_M is derived from the QD_M (see Chapter 2). QSA is effective on the QC_M . In QSA , propositions, which are the building blocks of the QC_M rules, stand for the landmarks of qualitative variables. The propositions are replaced with their equivalent landmarks. Perturbation is defined qualitatively as forcing a landmark of a qualitative variable to shift to its neighboring landmark. Sensitivity is a factor demonstrating the effect of perturbation on QC_M . Sensitivity is defined qualitatively in terms of possible shifts to the neighboring landmarks due to a remote perturbation. QSA can derive the sensitivity of the higher rank landmarks, ordered by the causal ordering technique, due to perturbation affecting the lower rank ones. Shallow rules-of-thumb are generated automatically from the detected sensitive cases. Such rules are added to the knowledge base and checked by the rule verifier. The approach is explained for the system shown in Figure 2.5.

3.2 Qualitative Sensitivity Analysis

It is a fundamental assumption that human being has a preference for reasoning based on *state information* [97]. States of the QC_M are given by complete subsets of propositions that embody the true proposition according to the order of truth propagation. The causal ordering (CO) technique [65] can derive the complete subsets for a given set of initial facts and hypotheses. All the propositions belonging to a complete subset possess the same ordering rank (r). The normal behavior of the system is the sequence of states ordered according to the increasing rank.

Sensitivity is a factor of measuring the propagation of a perturbation on the QC_M . Perturbation is defined qualitatively in terms of an event forcing a landmark value of a qualitative variable shift to its neighboring ones. For example, in Figure 2.5 when CV_1 and CV_3 closed, a leak from either valves makes the $H_{T_1}^o$ shift towards either $H_{(T_1)max}$ or $H_{(T_1)min}$. QSA detects possible effects of such shift on the other variables. It can derive sensitivity of the higher rank landmarks, due to perturbation affecting the lower rank ones [36].

Definition 3.2.1 (Qualitative Sensitivity) Let L_U^i and L_U^{i+1} be two neighboring landmark values of a qualitative variable U . Let L_V^j and L_V^{j+1} be the two neighboring landmark values of another qualitative variable V . Suppose that perturbation is introduced to L_V^j , causing L_V^j to shift to L_V^{j+1} . Then L_U^i is called sensitive to such perturbation, if L_V^j is an antecedent for L_U^i , in a causally ordered network, and if L_U^{i+1} , happens to have the same rank with the L_U^i on the same network. This is shown by:

$$(L_U^i, L_U^{i+1}) \ \aleph \ (L_V^j, L_V^{j+1}) \quad (3.1)$$

(\aleph) is the symbol denoting the qualitative sensitivity.

Lemma 3.2.1 (QSA) Qualitative sensitivity analysis is carried out as follows:

- Derive complete subsets by the causal ordering (CO) for the union of the initial fact and hypothesis sets, $\mathcal{F} \cup \mathcal{H}$.
- Treat each new perturbation as a new hypothesis and derive the perturbed complete subsets for the new set of facts and hypotheses, by CO.
- Check the complete subsets for the existence of the landmark values of a variable having the same rank.

For the example system the fact set, indicating the order of opening control valves, is,

$$\begin{aligned} \mathcal{F} = \{ & (\Omega_{CV_1} > 0), (\Omega_{CV_4} > 0), (\Omega_{CV_5} = 0), \\ & (\Omega_{CV_2} > 0), (\Omega_{CV_3} > 0), (\Omega_{CV_6} > 0) \} \end{aligned} \quad (3.2)$$

The hypothesis set, \mathcal{H} , is composed of some assumptions such as the initial pressure in the tank T_2 is higher than T_1 .

$$\mathcal{H} = \{(P_{T_2}^o > P_{T_1}^o)\} \quad (3.3)$$

For the QC_M rules given in Section 2.5, and for the above fact and hypothesis sets the complete subsets are derived,

$$\begin{aligned} (r = 1) \Rightarrow \{ & (\Omega_{CV_1} > 0), (\Omega_{CV_4} > 0), (\Omega_{CV_5} = 0), (\Omega_{CV_2} > 0), \\ & (\Omega_{CV_3} > 0), (\Omega_{CV_6} > 0), (P_{T_2}^o > P_{T_1}^o) \} \\ (r = 2) \Rightarrow \{ & (U_1 > 0), (U_2 > 0), (J_1 = 0), (0 < F_{out/T_2} \leq F_{(out/T_2)max}), \\ & (P_{T_1}^o < P_{T_1} \leq P_{(T_1)max}), (0 < A_{in/T_1} \leq A_{(in/T_1)max}) \} \end{aligned} \quad (3.4)$$

Suppose that perturbation is introduced to the proposition ($\Omega_{CV_4} > 0$). The neighboring landmark, that is ($\Omega_{CV_4} = 0$), is treated as a new hypothesis, added to the $\mathcal{F} \cup \mathcal{H}$. Causal ordering derives the new ordering for the new $\mathcal{F} \cup \mathcal{H}$,

$$\begin{aligned}
 (r = 1) \Rightarrow & \{(\Omega_{CV_1} > 0), (\Omega_{CV_4} > 0), (\Omega_{CV_4} = 0), (\Omega_{CV_5} = 0), \\
 & (\Omega_{CV_2} > 0), (\Omega_{CV_3} > 0), (\Omega_{CV_6} > 0), (P_{T_2}^o > P_{T_1}^o)\} \\
 (r = 2) \Rightarrow & \{(0 < F_{out/T_2} \leq F_{(out/T_2)max}), (P_{T_1}^o < P_{T_1} \leq P_{(T_1)max}), \\
 & (P_{(T_1)min} \leq P_{T_1} < P_{T_1}^o), (0 < A_{in/T_1} \leq A_{(in/T_1)max}), (A_{out/T_2} = 0), \\
 & (P_{T_2}^o < P_{T_2} \leq P_{(T_2)max}), (A_{in/T_1} = 0), (J_1 = 0), (U_2 > 0), (U_1 > 0)\} \quad (3.5)
 \end{aligned}$$

In this case the landmark values of the variables A_{in/T_1} and P_{T_1} appear to have the same rank, therefore according to Definition 3.2.1, they are sensitive to perturbation introduced to ($\Omega_{CV_4} > 0$),

$$[(A_{in/T_1} = 0), (0 < A_{in/T_1} \leq A_{(in/T_1)max})] \ \& \ [(\Omega_{CV_4} > 0), (\Omega_{CV_4} = 0)] \quad (3.6)$$

$$[(P_{(T_1)min} \leq P_{T_1} < P_{T_1}^o), (P_{T_1}^o < P_{T_1} \leq P_{(T_1)max})] \ \& \ [(\Omega_{CV_4} > 0), (\Omega_{CV_4} = 0)] \quad (3.7)$$

3.3 Generating Shallow Rules of Thumb

rules of thumb are empirical associations between an observed behavior and the possible faults [85]. QS_A is applied to generate such rules. Suppose that p, q, r and s are the corresponding propositions for the landmark values L_U^i , L_U^{i+1} , L_V^j and L_V^{j+1} in (3.1), respectively. Let p and r represent a rule in the QC_M . Then the other two propositions can depict a rule of thumb in the sense that the cause of observing an specific behavior (i.e., in this case shown by proposition q) is a perturbation in one of its direct or indirect antecedents (i.e., indirect cause is the proposition s in this case). The rule of thumb is,

$$q \leftarrow s \quad (3.8)$$

Or in descriptive form: "If q is observed, its possible cause is s".

Lemma 3.3.1 (Generating Diagnostic rules) *Diagnostic rules are generated as follows:*

- *Derive all the sensitive cases, for a given perturbation and record them in the form of (3.1).*
- *Replace the landmark values with the corresponding propositions for each sensitive case.*
- *Delete the propositions representing a relation in the QC_M rules. Remaining propositions represent a rule of thumb having the form of,*

$$(q_1 \vee q_2 \vee \dots \vee q_n) \leftarrow s \quad (3.9)$$

Implying that s is a possible cause of the accumulated evidences (q_1-q_n) .

Applying Lemma 3.3.1 to (3.6)–(3.7) and deleting the originally related landmark values in them leads the following rule,

$$[0 = A_{in/T_1}] \vee [P_{(T_1)min} \leq P_{T_1} < P_{T_1}^o] \leftarrow [\Omega_{CV_4} = 0] \quad (3.10)$$

This can be interpreted as: “If the net pressure of the tank T_1 is reduced, check the flow of air into the tank. If the flow is halted, then deduce that the pressure valve CV_4 is possibly clogged.”

3.4 Discourse Understanding System

Sensitivity analysis can also be applied to give answer to “*what . . . if*” questions. For the same system let’s find the answer to the question: “What will happen if the pressure valves CV_4 is clogged while CV_5 is opened?” The propositions $(\Omega_{CV_4} = 0)$: ‘ CV_4 is clogged’ and $(\Omega_{CV_5} > 0)$: ‘ CV_5 is opened’ are treated as a new hypothesis and the causal ordering derives the new ordering.

$$\begin{aligned} \mathcal{F} \cup \mathcal{H} = \{ & (\Omega_{CV_1} > 0), (\Omega_{CV_4} > 0), (\Omega_{CV_4} = 0), \\ & (\Omega_{CV_5} = 0), (\Omega_{CV_5} > 0), (\Omega_{CV_2} > 0), \\ & (\Omega_{CV_3} > 0), (\Omega_{CV_6} > 0), (P_{T_2}^o > P_{T_1}^o) \} \end{aligned} \quad (3.11)$$

Complete subsets including perturbation are:

$$\begin{aligned} (r = 1) & \Rightarrow \{ \mathcal{F} \cup \mathcal{H} \} \\ (r = 2) & \Rightarrow \{ (0 < F_{out/T_2} < F_{(out/T_2)max}), (U_1 > 0), (U_2 > 0), \\ & (P_{(T_1)min} \leq P_{T_1} < P_{T_1}^o), (P_{T_1}^o < P_{T_1} \leq P_{(T_1)max}), \end{aligned}$$

$$\begin{aligned}
 & (A_{in/T_1} = 0), (0 < A_{in/T_1} \leq A_{(in/T_1)max}), (J_1 = 0), \\
 & (0 < A_{out/T_2} \leq A_{(out/T_2)max}), (J_1 > 0), (A_{out/T_2} = 0), \\
 & (P_{T_2}^o < P_{T_2} \leq P_{(T_2)max}), (P_{(T_2)min} \leq P_{T_2} < P_{T_2}^o) \} \quad (3.12)
 \end{aligned}$$

Sensitive cases are:

$$\begin{aligned}
 & [(A_{in/T_1} = 0), (0 < A_{in/T_1} \leq A_{(in/T_1)max})] \ \& \ \& \\
 & [(\Omega_{CV_4} = 0), (\Omega_{CV_4} > 0)] \wedge [(\Omega_{CV_5} = 0), (\Omega_{CV_5} > 0)] \quad (3.13)
 \end{aligned}$$

$$\begin{aligned}
 & [(P_{(T_1)min} \leq P_{T_1} < P_{T_1}^o), (P_{T_1}^o < P_{T_1} \leq P_{(T_1)max})] \ \& \ \& \\
 & [(\Omega_{CV_4} = 0), (\Omega_{CV_4} > 0)] \wedge [(\Omega_{CV_5} = 0), (\Omega_{CV_5} > 0)] \quad (3.14)
 \end{aligned}$$

$$\begin{aligned}
 & [(A_{out/T_2} = 0), (0 < A_{out/T_2} \leq A_{(out/T_2)max})] \ \& \ \& \\
 & [(\Omega_{CV_4} = 0), (\Omega_{CV_4} > 0)] \wedge [(\Omega_{CV_5} = 0), (\Omega_{CV_5} > 0)] \quad (3.15)
 \end{aligned}$$

$$\begin{aligned}
 & [(P_{(T_2)min} \leq P_{T_2} < P_{T_2}^o), (P_{T_2}^o < P_{T_2} \leq P_{(T_2)max})] \ \& \ \& \\
 & [(\Omega_{CV_4} = 0), (\Omega_{CV_4} > 0)] \wedge [(\Omega_{CV_5} = 0), (\Omega_{CV_5} > 0)] \quad (3.16)
 \end{aligned}$$

$$\begin{aligned}
 & [(J_1 = 0), (J_1 > 0)] \ \& \ \& \\
 & [(\Omega_{CV_4} = 0), (\Omega_{CV_4} > 0)] \wedge [(\Omega_{CV_5} = 0), (\Omega_{CV_5} > 0)] \quad (3.17)
 \end{aligned}$$

Applying Lemma 3.3.1 derives the following rule:

$$\left\{ \begin{array}{l} (A_{in/T_1} = 0) \quad \vee \\ (P_{(T_1)min} \leq P_{T_1} < P_{T_1}^o) \quad \vee \\ (P_{T_2}^o < P_{T_2} \leq P_{(T_2)max}) \quad \vee \\ (A_{out/T_2} = 0) \quad \vee \\ (J_1 > 0) \quad \vee \end{array} \right\} \leftarrow \{ (\Omega_{CV_4} = 0) \wedge (\Omega_{CV_5} > 0) \} \quad (3.18)$$

This is interpreted as: "Clogging of the pressure valve CV_4 while CV_5 is opened may possibly halt the flow of air out of T_2 and into T_1 , reduce the pressure of tank T_1 , increase of pressure of tank T_2 , and a flow of compressed air from T_2 to the reservoir tank."

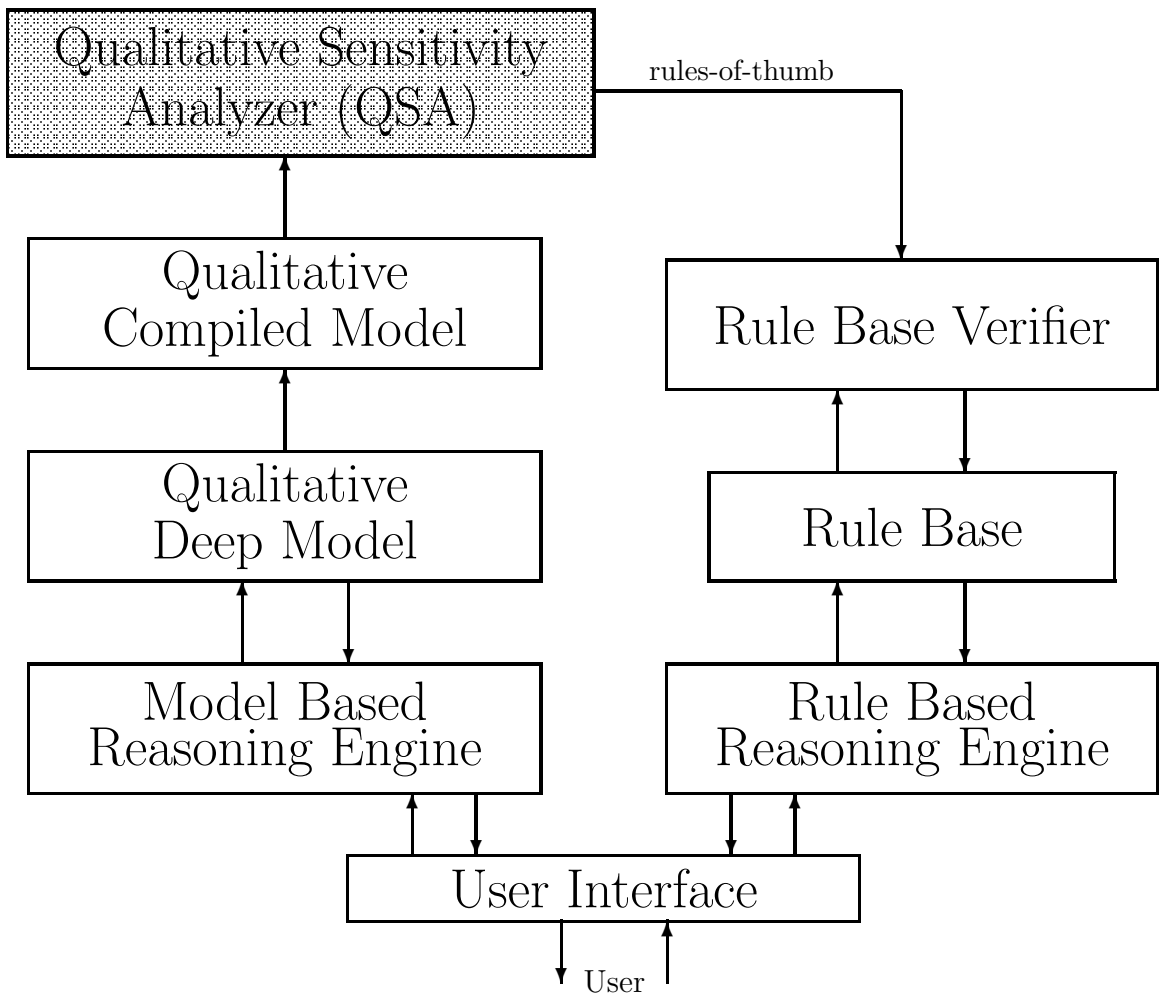

Figure 3.1: Qualitative sensitivity analyzer.

Chapter 4

Research on Subjective Fault Diagnosis: A Subjective Approach to Qualitative Fault Diagnosis in Systems with Nonintermittent Concurrent Faults

4.1 Introduction

Major approaches to automatic fault diagnosis of industrial plants and processes are either subjective or objective. Subjective approaches imitate and synthesize the way that human experts diagnose faults. Objective approaches automate a portion of the fault diagnosis task that human's cognitive limitation does not allow handling it efficiently, mainly because of limited capacity of the short term memory and inefficiency in managing precise calculation. Subjective approach to fault diagnosis is the main theme of this chapter.

Currently available subjective fault diagnosis techniques suffer from certain drawbacks such as: lack of knowledge for modeling and reasoning with the required levels of detail; inefficiency in utilization of sensory data; and poor in learning experienced schemata. A subjective approach to fault diagnosis, using qualitative modeling and reasoning within the multiple view of the system is introduced. The focus is on automation of the cognitive skills of human experts, that include utilizing conceptual models to detect inherent redundancy in system behavior; qualitative reasoning to predict future states; and information selection to avoid computation overload.

To summarize, the Subjective Qualitative Fault Diagnosis (S^F_D) technique is introduced, featuring:

- Modeling human expert's knowledge within the S-R-K hierarchical framework.
- Extending conventional qualitative models to include the coordination and timing of events

and using conventional qualitative simulation to generate complete set of normal and abnormal behaviors from the extended qualitative model and qualitative interpretation of sensory data.

- Generating passive component of the knowledge base [79] (i.e. compiled model) from the active component (i.e. qualitative deep model).
- Model based learning of fault diagnosis heuristics (i.e. *rules-of-thumb*).
- Generating concurrent fault hypotheses, testing them for validity and deriving what may be affected by valid faults.

S^F_D can serve as a knowledge based aiding system, managing to minimize the cognitive overload of the human operators by reducing the inferences that they have to make when reasoning about faults.

4.2 Conventional Fault Diagnosis: A Comparative Survey

Human's performance (in terms of speed, accuracy and efficiency) in fault diagnosis¹ degrades drastically with the increase of size and complexity of the plant [95, 123]. In order to increase the reliability of decisions made by the operators and meeting the performance issues, partial automation of fault diagnosis tasks is desirable. An automated fault diagnosis system may include, various forms of data on physical components and instrumentation, models of behavior, failure modes of the components, fault trees and state transition diagrams, thresholds and limit values of the variables, experienced or predicted schemes, heuristic rules to limit the search space, etc. Both subjective and objective fault diagnosis systems involve generation and evaluation of signals for given fault hypotheses. Models, embodying individual entities (i.e. mathematical or symbolic generalization of the signals and their relationships), are found useful.

Two classes of representation models, quantitative and qualitative, are considered in the system diagnosis literature. Qualitative models can predict the ordering of events and direction of changes, while quantitative models can give numerical predictions [116]. Fault diagnosis techniques, utilizing quantitative models, vary depending on the selection of individual entities (i.e. measurable signals, nonmeasurable variables or characteristic quantities, etc.) [23, 22, 64, 9, 48]. Recently, techniques have been emerged using qualitative models [52, 29, 93, 72]. They are the outcomes of the merger of new AI paradigms (e.g. assumption based truth maintenance

¹ the term *fault diagnosis* means observing an error and deriving possible faults causing that error. In some texts the former task is called *fault detection* and the latter is named *fault diagnosis* (e.g. [64]). Detection, diagnosis and correction together are called *fault management* [66].

The terms *fault* and *error* are used in the sense that an error occurs when system deviates from its specified normal behavior, and the error is caused by a fault [107]. The fault is assumed to be *atomic* (either happens fully or not) *nonintermittent* (i.e. lasts over a considerable long time, as opposed to transient faults) and *logical* (i.e. affecting the system behavior). *Parametric faults* causing a gradual change in performance, such as changing speed or aging [15], are not accounted for in this report.

ATMS, nonmonotonic reasoning, etc.), expert system technology and qualitative simulation techniques. these systems are either *structure oriented* [42, 76] or *procedure oriented* [53, 54], and can be classified based on using *shallow* models [105, 100], *deep* models [29, 72], or a combination of both [1, 43].

4.2.1 Structure Oriented Approach

A common underlying assumption in qualitative model based fault diagnosis techniques is *structural compositionality*, i.e. the system is broken down to its structural components and description of system behavior is derived from its structure. They first isolate a faulty region in the system and then employ additional test (e.g. heuristic rules or assumption verification) to verify the fault hypothesis and identify the exact problem [77] (see Figure 4.7). In this sense, *shallow* techniques may involve reasoning from the compiled behaviors of the various components. *Deep* techniques may include more sophisticated models of the components including knowledge of the variables interaction or functional relations [77].

Structure oriented fault diagnosis techniques have certain drawbacks, such as: counter intuitive diagnosis² [84]. Furthermore, inefficiency in knowledge representation and utilization of sensory data together may lead to computation overload, making it difficult to design time critical fault diagnosis systems [78, 123].

It is stated that in structure oriented approach, representation by structure and functions does not make apparent the relation between an observed behavior and a fault [56]. Specially, in a concurrent faults case, a fault in a local component can be propagated to the others, producing secondary symptoms and activating multiple alarms. Determining the behavior of the system due to each particular fault and then combining them to produce the behavior for concurrent faults is a necessity. In \mathcal{S}_D^{SF} we have considered ways of explicitly representing deviations of the behavior for concurrent faults and methods of avoiding ambiguities when simulating the behavior.

4.2.2 Procedure Oriented Approach

In procedure oriented approach a process is defined by a sequence of actions. The set of all behaviors of a process constitutes the actions [53, 54]. This definition of process is useful only when the relation between the actions and other modeling primitives, such as variables, can be established. In procedural fault diagnosis, the knowledge has an invocation and a body (see Figure 4.7). The invocation is external to the body and test expressions are internal. They both may address a fault. Invocation is a logical expression that includes functions that examine the current goals and facts. Invocation can be either goal oriented (i.e. for a fault hypothesis: proving that a fault exists), or fact oriented (i.e. for an observed symptom). A test is a logical

² In complex and dynamic systems with numerous components, a fault can be propagated to the other subsystems and reasoning within the subsystem might lead to intuitively right but ultimately wrong fault hypotheses (see [84]).

expression including functions for evaluating the newly established facts. A main problem is that without establishing a hypothesis, conducting a particular test is impossible because the body including specialized inference procedure can only be accessed when the invocation expression is evaluated to true. Another problem with procedural fault diagnosis is that it cannot learn diagnosis strategies. We found it useful to define the processes as a sequence of qualitative variables related by qualitative operations in the deep level representation (see Section 4.4), and we show that such representation (deep level) can produce the sequence of actions in another level of abstraction (compiled level). Also ambiguity between the invocation and test expressions is avoided.

4.2.3 Subjective Approach

Subjective approach describes and imitates the way that human performs fault diagnosis, with concentration on either imitating the behavior or achieving the same level of performance. Human performance in fault diagnosis degrades with the increase of the size of the plant and complexity of its behavior. Figure 4.7 depicts some fundamental problems manifesting the performance [37]. The mental workload [104] (cognitive overload [84]) due to large amounts of monitored data, is the main limiting factor of the performance, leading to cognitive tunnelling and incorrect decisions. The control directness problem [63] arises when the effects of a correction action is propagated along the causal chains until reaching the target point on which the action cannot be direct. The information accessibility problem arises when the information needed to confirm a fault hypothesis is not directly accessible and must be inferred indirectly. Human operators come up with diagnosis decisions by comparing observed behavior with the desired response. The counter intuition problem arises when the ability to anticipate the plant's response is narrowed down by a number of factors, such as mutual influence of the overlapping processes, nonlinearities in the plant's dynamics and long time delays in system response. Two ways of enhancing the performance are [70]:

- Utilizing conceptual models of the plant that allow detecting redundancies in system behavior and predict the future states.
- Utilizing efficient information selection and transformation tools to avoid cognitive (computation) overload.

Some symptomatic fault diagnosis systems, coding human experts' knowledge, are the first generation of subjective systems. However, they apparently come short when trying to achieve the human's performance level. Systems including models of human behavior [8, 18] have been appeared. Categories of the fault detection, diagnosis and correction from the S-R-K perspective are defined [66], indicating a need for more powerful knowledge based level fault detection and diagnosis techniques.

In \mathcal{S}_D^F we focus on knowledge and rule based levels of the S-R-K, and show that the control directness and information accessibility problems can be removed by using the qualitative deep model and qualitative interpretation of sensory data. Decomposing the deep model removes problems with the overlapping processes. Finally, the qualitative nature of the model is a way of dealing with nonlinearities in plant dynamics.

Most of the existing techniques have been concentrated on systems related to one of the S-R-K levels [66] with some exceptions, such as *Integrated Diagnostic Model (IDM)* [43]. \mathcal{S}_D^F is different from IDM in the sense that the passive component of knowledge (i.e. compiled model) is generated directly from the deep qualitative model and the deep level representation is semantically richer.

4.3 Subjective Qualitative Fault Diagnosis Technique

\mathcal{S}_D^F embodies a hierarchy of two interacting fault diagnosis techniques: *deep* for the knowledge based level and *compiled* for the rule based level of the R-S-K (see Figure 4.7). The techniques are explained with the plant shown in Figure 2.5 in Chapter 2.

4.3.1 Knowledge Based Level

Model of the normal system is the Q_{EG} that embodies Qualitative Processes (QP). Behavioral Fragments (BF) are defined as characteristic behavior of the QPs. Behavior of the normal system is the set of BFs and derived from Q_{EG} by qualitative simulation. Most of the problems in process malfunction are caused by failure of the control and instrumentation components (e.g. leaking a valve). Such components have a defined set of potential failure modes [43, 51], called failure modes of system components, Ψ . Faults, addressing failure modes are modeled by *dependency constraints* which are the antecedents of the conditional arcs of Q_{EG} . From Q_{EG} and Ψ one can derive Diversified Behavioral Fragments (DBFs), set of behaviors of the malfunctioning system, different from BFs. Observed behavioral information, $\tilde{\Theta}$, is provided by the sensors and interpreted qualitatively [47]. The problem is finding whether $\tilde{\Theta}$ is similar to either BFs or DBFs, and soliciting candidate faults. If $\tilde{\Theta}$, is qualitatively *similar* to one of the behaviors of the BF set, it can be a possible behavior of the normal system. On the other hand, if it is similar to a behavior of the DBF set, it can be a possible behavior of the faulty system and the invocation part of the fault arc is the causes of malfunctioning.

In this level, behavioral information are recorded for the qualitative variables. Sensory data is also recorded and qualitatively interpreted for the variables, therefore comparison of an observed behavior with a recorded normal or perturbed behavior is reduced to comparing a limited number of landmark values and dependency constraints for the two behaviors, resulting less computation overload (see Section 4.4 below).

4.3.2 Rule Based Level

QC_M of the normal system and a set of components' malfunctions, Ψ , are given. QC_M embodies rules describing processes activated by the normal system. Each rule is composed of antecedent and consequent propositions. Ψ involves propositions addressing failure modes of the components. The set of predicted behaviors, Γ_c , is derived from Ω_c using causal ordering (CO) technique [65]. CO derives ordering among the propositions for a given set of initial settings treated as facts. The elements of Ψ are treated as new hypotheses and from QC_M and Ψ one can derive another set of behaviors of the faulty system, $\tilde{\Gamma}_c$, different from Γ_c . Qualitative Sensitivity Analysis (QSA) technique checks the sensitivity of behavior to faults and preserves the results in the form of a diagnostic rule [34].

4.3.3 Hierarchy of Knowledge and Rule Based Levels

A hierarchy of knowledge and rule based levels can offer substantial advantage over a single one. A basic feature of this technique is that first, QC_M is extracted from the QD_M and then diagnostic rules are generated from QC_M . Generated diagnostic rules are different from the heuristic rules, in the so called *symptomatic* (experience based) fault diagnosis, in the sense that they have an underpinning model, being more accurate and reliable than heuristic rules. Such diagnostic rules can be used in an ordinary symptomatic expert diagnosis system. Generating and validating concurrent fault hypotheses and assessment of situation are additional features of the hierarchical system.

4.4 Knowledge Based Level Qualitative Fault Diagnosis

The Knowledge based level allows reasoning from the interaction of the variables at the process level. Some concepts such as QD_M , QFG , qualitative process (QP), behavioral fragment (BF) have been defined already. Here the *diversified behavioral fragment* (DBF) and *similarity* concepts are defined. They lead to an insightful understanding of the system's behavior and functions.

4.4.1 Qualitative Observed Behavior

An observed behavior for a qualitative variable V is read by the sensors and is interpreted qualitatively as a finite sequence of pairs (L_V^k, T_V^k) , having the form given in (2.1) [47].

Assumption 4.4.1 For a set of qualitative processes \mathcal{P} , every observed behavior $\tilde{\Theta}$, is associated with a subset of processes $\tilde{\mathcal{P}}$, i.e., $\tilde{\Theta}$ can be derived by qualitative simulation on the $\tilde{\mathcal{P}}$.

Faults are modeled by clock and dependency constraints and errors by landmark values of qualitative variables. Distinguishing between these two is necessary because naturally an error is measurable, but a fault is not. Errors, such as low pressure in tanks, etc., are derived by limit and trend analysis of the variables, to which a sensor can be attached. However, a fault, such as clogging or leaking a valve, cannot be measured directly and can only be manifested through other measurable variables. We define here the relation between the observed behavior and the *fault arcs*.

Definition 4.4.1 (Fault Arc) For an observed behavior, $\tilde{\Theta}$, associated with $\tilde{\mathcal{P}}$, a fault arc is the one whose dependency constraint is evaluated to a different value than that of the processes \mathcal{P} . For c_F and $O \in \mathcal{O}$,

$$FA = \{\exists j, a_F : (c_F \rightarrow O) \mid \mathcal{E}(c_F)_{P_j} \neq \mathcal{E}(c_F)_{\tilde{P}_j}\} \quad (4.1)$$

$\mathcal{E}(c_F)_{P_j}$ and $\mathcal{E}(c_F)_{\tilde{P}_j}$ are evaluations of the constraint c_F for the process P_j and \tilde{P}_j , respectively.

FA is the set of fault arcs. P_j and \tilde{P}_j are processes belonging to the \mathcal{P} and $\tilde{\mathcal{P}}$, respectively. Each $a_F \in FA$, c_F addresses a fault.

4.4.2 Diversified Behavioral Fragment

The deviations from the behavior of the normal system, i.e., characteristic behaviors of the faulty system are defined by the diversified behavioral fragments (DBF). DBFs reflect the effect of propagation of a fault in a set of processes. Similar to BFs, DBFs are also derived by qualitative simulation when applying the conditional arcs one by one.

Definition 4.4.2 (Diversified Behavioral Fragment) Diversified Behavioral Fragment for the process P_j is,

$$\exists c_F, \forall V \in P_j, \quad DBF(c_F)_{P_j} = \left\{ \bigoplus_{k=0}^n L_V^k(c_F) \right\} \quad (4.2)$$

V is a displayed qualitative variable and c_F is a fault arc.

DBFs for the example system are given below. Possible malfunctions of a control valve in the example are either leaking when the valve is set closed, or clogged when it is set opened. Two classes of faults are considered for each valve:

- Clogged when enabled; in this case a valve CV_i behaves as if it is disabled.
- Leaking when disabled; in this case a valve CV_i behaves as if it is enabled.

The malfunction set is composed of:

$$\Psi = \left\{ \begin{array}{lll} \omega_{CV_1}^2 = 0 & (\omega_{CV_2}^2 = 0) & (\omega_{CV_3}^2 = 0) \\ \omega_{CV_1}^2 = 1 & (\omega_{CV_2}^2 = 1) & (\omega_{CV_3}^2 = 1) \\ \omega_{CV_4}^2 = 0 & (\omega_{CV_5}^2 = 0) & (\omega_{CV_6}^2 = 0) \\ \omega_{CV_4}^2 = 1 & (\omega_{CV_5}^2 = 1) & (\omega_{CV_6}^2 = 1) \end{array} \right\} \quad (4.3)$$

- $\omega_{CV_1}^2 = 0$ ($\omega_{CV_1}^2 = 1$): CV_1 clogged (leaking); affecting processes P_3 , P_4 and P_5 ;
 $\omega_{CV_2}^2 = 0$ ($\omega_{CV_2}^2 = 1$): CV_2 clogged (leaking); affecting processes P_6 , P_7 and P_8 ;
 $\omega_{CV_3}^2 = 0$ ($\omega_{CV_3}^2 = 1$): CV_3 clogged (leaking); affecting processes P_1 and P_2 ;
 $\omega_{CV_4}^2 = 0$ ($\omega_{CV_4}^2 = 1$): CV_4 clogged (leaking); affecting processes P_{10} , P_{11} , P_{12} and P_{13} ;
 $\omega_{CV_5}^2 = 0$ ($\omega_{CV_5}^2 = 1$): CV_5 clogged (leaking); affecting processes P_{14} , P_{15} and P_{16} ;
 $\omega_{CV_6}^2 = 0$ ($\omega_{CV_6}^2 = 1$): CV_6 clogged (leaking); affecting process P_9 ;

DBFs for the system are:

$$\begin{aligned}
 DBF(\omega_{CV_3}^2 = 0)_{P_1} &= (\Omega_{CV_3} : 0), & K_2 : 0) \\
 DBF(\omega_{CV_3}^2 = 1)_{P_1} &= (\Omega_{CV_3} > 0), & K_2 > 0) \\
 DBF(\omega_{CV_3}^2 = 0)_{P_2} &= (\Omega_{CV_3} : 0), & (H_{T_1} : H_{T_1}^o) \\
 DBF(\omega_{CV_3}^2 = 1)_{P_2} &= (\Omega_{CV_3} > 0), & (H_{(T_1)min} \leq H_{T_1} < H_{T_1}^o) \\
 DBF(\omega_{CV_1}^2 = 0)_{P_3} &= (\Omega_{CV_1} : 0), & (H_{T_1} : H_{T_1}^o) \\
 DBF(\omega_{CV_1}^2 = 1)_{P_3} &= (\Omega_{CV_1} > 0) & (H_{T_1}^o < H_{T_1} \leq H_{(T_1)max}) \\
 DBF(\omega_{CV_1}^2 = 0)_{P_4} &= (\Omega_{CV_1} : 0), & (H_{T_2} : H_{T_2}^o) \\
 DBF(\omega_{CV_1}^2 = 1)_{P_4} &= (\Omega_{CV_1} > 0) & (H_{(T_2)min} \leq H_{T_2} < H_{T_2}^o) \\
 DBF(\omega_{CV_1}^2 = 0)_{P_5} &= (\Omega_{CV_1} : 0), & (F_{out/T_2} : 0) \\
 DBF(\omega_{CV_1}^2 = 1)_{P_5} &= (\Omega_{CV_1} > 0) & (0 < F_{out/T_2} \leq F_{(out/T_2)max}) \\
 DBF(\omega_{CV_2}^2 = 0)_{P_6} &= (\Omega_{CV_2} : 0), & (F_{out/T_2} : 0) \\
 DBF(\omega_{CV_2}^2 = 1)_{P_6} &= (\Omega_{CV_2} > 0) & (0 < F_{out/T_2} \leq F_{(out/T_2)max}) \\
 DBF(\omega_{CV_2}^2 = 0)_{P_7} &= (\Omega_{CV_2} : 0), & (H_{T_2} : H_{T_2}^o) \\
 DBF(\omega_{CV_2}^2 = 1)_{P_7} &= (\Omega_{CV_2} > 0) & (H_{(T_2)min} \leq H_{T_2} < H_{T_2}^o) \\
 DBF(\omega_{CV_2}^2 = 0)_{P_8} &= (\Omega_{CV_2} : 0), & (K_1 : 0) \\
 DBF(\omega_{CV_2}^2 = 1)_{P_8} &= (\Omega_{CV_2} > 0) & (K_1 > 0) \\
 DBF(\omega_{CV_6}^2 = 0)_{P_9} &= (\Omega_{CV_6} : 0), & (H_{T_2} : H_{T_2}^o) \\
 DBF(\omega_{CV_6}^2 = 1)_{P_9} &= (\Omega_{CV_6} > 0) & (H_{T_2}^o < H_{T_2} \leq H_{(T_2)max}) \\
 DBF(\omega_{CV_4}^2 = 0)_{P_{10}} &= (\Omega_{CV_4} : 0), & (P_{T_1} : P_{T_1}^o) \\
 DBF(\omega_{CV_4}^2 = 1)_{P_{10}} &= (\Omega_{CV_4} > 0) & (P_{T_1}^o < P_{T_1} \leq P_{(T_1)max}) \\
 DBF(\omega_{CV_4}^2 = 0)_{P_{11}} &= (\Omega_{CV_4} : 0), & (A_{in/T_1} : 0) \\
 DBF(\omega_{CV_4}^2 = 1)_{P_{11}} &= (\Omega_{CV_4} > 0) & (0 < A_{in/T_1} \leq A_{(in/T_1)max}) \\
 DBF(\omega_{CV_4}^2 = 0)_{P_{12}} &= (\Omega_{CV_4} : 0), & (A_{out/T_2} : 0) \\
 DBF(\omega_{CV_4}^2 = 1)_{P_{12}} &= (\Omega_{CV_4} > 0) & (0 < A_{out/T_2} \leq A_{(out/T_2)max})
 \end{aligned}$$

$$\begin{aligned}
 DBF(\omega_{CV_4}^2 = 0)_{P_{13}} &= (\Omega_{CV_4} : 0), & (P_{T_2} : P_{T_2}^o) \\
 DBF(\omega_{CV_4}^2 = 1)_{P_{13}} &= (\Omega_{CV_4} > 0)], & (P_{(T_2)min} \leq P_{T_2} < P_{T_2}^o) \\
 DBF(\omega_{CV_5}^2 = 0)_{P_{14}} &= (\Omega_{CV_5} : 0), & (P_{T_2} : P_{T_2}^o) \\
 DBF(\omega_{CV_5}^2 = 1)_{P_{14}} &= (\Omega_{CV_5} > 0) & (P_{(T_2)min} \leq P_{T_2} < P_{T_2}^o) \\
 DBF(\omega_{CV_5}^2 = 0)_{P_{15}} &= (\Omega_{CV_5} : 0), & (A_{out/T_2} : 0) \\
 DBF(\omega_{CV_5}^2 = 1)_{P_{15}} &= (\Omega_{CV_5} > 0) & (0 < A_{out/T_2} \leq A_{(out/T_2)max}) \\
 DBF(\omega_{CV_5}^2 = 0)_{P_{16}} &= (\Omega_{CV_5} : 0), & (J_1 : 0) \\
 DBF(\omega_{CV_5}^2 = 1)_{P_{16}} &= (\Omega_{CV_5} > 0) & (J_1 > 0)
 \end{aligned}$$

4.4.3 Detecting Candidate Faults

Candidate faults are detected by comparing the observed behaviors with the BFs (behaviors of the normal system) and DBFs (behaviors including a fault), using *similarity* concept, defined qualitatively below.

Definition 4.4.3 (Similarity) For a qualitative variable V belonging to a process P_j , two different behaviors, $(\uplus_{k=1}^n L_V^k)$ and $(\uplus_{k=1}^n \tilde{L}_V^k)$ are called 'similar' if, either,

$$\forall k, \quad L_V^k = \tilde{L}_V^k$$

or,

$$\begin{aligned}
 \forall k, \quad \partial L_V^k > 0 &\rightarrow \partial \tilde{L}_V^k > 0 \\
 \forall k, \quad \partial L_V^k < 0 &\rightarrow \partial \tilde{L}_V^k < 0 \\
 \forall k, \quad \partial L_V^k = 0 &\rightarrow \partial \tilde{L}_V^k = 0
 \end{aligned} \tag{4.4}$$

The ∂L_V^k indicates the direction of change between the two neighboring landmark values.

Lemma 4.4.1 (Candidate Fault Detection) For an observed behavior $\tilde{\Theta}$ of a qualitative variable V ,

- For each process P_j , where $V \in P_j$, compare $\tilde{\Theta}$ with the portion of the $BF_{P_j}(V)$ for the qualitative variable V .
- If the $BF_{P_j}(V)$ and $\tilde{\Theta}$ are similar, conclude that $\tilde{\Theta}$ is a possible behavior of the normal system, or the fault is undetectable.
- Otherwise, for each process P_j , compare $\tilde{\Theta}$ with the DBFs of the qualitative variable V .
- If a DBF is similar to $\tilde{\Theta}$, the fault arc c_F of the $DBF(c_F)_{P_j}$ embodies the fault.

Let's consider two cases of an observed behavior (4.5): no change (Case 1.1) and decrease

(Case 1.2) of the liquid level in tank T_2 (Figure 2.5 Chapter 2). Such behaviors are interpreted qualitatively, by the expressions (4.6)–(4.7), respectively.

$$\tilde{\Theta}_1 = \{H_{T_2} \mid \tilde{L}_{H_{T_2}}^1, \tilde{L}_{H_{T_2}}^2\} \quad (4.5)$$

$$Case1.1: \quad \tilde{L}_{H_{T_2}}^2 = \tilde{L}_{H_{T_2}}^1 \quad (4.6)$$

$$Case1.2: \quad \tilde{L}_{H_{T_2}}^2 < \tilde{L}_{H_{T_2}}^1 \quad (4.7)$$

Applying Lemma 4.4.1 and comparing with the BFs in Chapter 2 shows that BF_{P_4} and BF_{P_7} are similar to (4.7), indicating that it can be a possible behavior of the normal system. (4.6) is not similar to any of the BFs. Comparing (4.6) with the DBFs in Chapter 2, recorded for the variable H_{T_2} , shows that 3 similar behaviors exist: $DBF(\omega_{CV_1}^2 = 0)_{P_4}$, $DBF(\omega_{CV_2}^2 = 0)_{P_7}$ and $DBF(\omega_{CV_6}^2 = 0)_{P_9}$. Fault arcs for the affected process are possible single candidate faults³:

- $(\omega_{CV_1}^2 = 0 : CV_1 \text{ clogged});$
- $(\omega_{CV_2}^2 = 0 : CV_2 \text{ clogged});$ and
- $(\omega_{CV_6}^2 = 0 : CV_6 \text{ clogged}).$

Candidate fault set for each case is given below.

$$Case1.1: \quad (\tilde{L}_{H_{T_2}}^2 = \tilde{L}_{H_{T_2}}^1) \rightarrow \{(\omega_{CV_1}^2 = 0), (\omega_{CV_2}^2 = 0), (\omega_{CV_6}^2 = 0)\} \quad (4.8)$$

As another example, observed behavior can be recorded for a number of displayed variables rather than only one. For instance, let's consider the case that the pressure in T_2 is steady and there is no flow of air from T_2 to T_1 , or in qualitative terms:

$$\tilde{\Theta}_2 = \{(A_{out/T_2} : 0), (P_{T_2} : P_{T_2}^o)\} \quad (4.9)$$

Comparing $\tilde{\Theta}_2$ with the BFs indicates that this cannot be a possible normal behavior. Comparison with the DBFs shows two similar cases, $DBF(\omega_{CV_4}^2 = 0)_{P_{12}}$ and $DBF(\omega_{CV_4}^2 = 0)_{P_{13}}$, as well as $DBF(\omega_{CV_5}^2 = 0)_{P_{14}}$ and $DBF(\omega_{CV_5}^2 = 0)_{P_{15}}$.

$$Case2.1: \quad (A_{out/T_2} : 0) \rightarrow \{(\omega_{CV_4}^2 = 0), (\omega_{CV_5}^2 = 0)\} \quad (4.10)$$

$$Case2.2: \quad (P_{T_2} : P_{T_2}^o) \rightarrow \{(\omega_{CV_4}^2 = 0), (\omega_{CV_5}^2 = 0)\} \quad (4.11)$$

\mathcal{S}_D^{SF} can detect most of the faults with short propagation time. After running a number of times on the same class of faults, the system becomes more efficient because it shifts automatically from the knowledge level to the skill level. However, a main problem is dealing with the long time lag in fault propagation: in some cases the effects of fault propagation in the

³ Note that ω_{CV_i} is a mod-3 integer but Ω_{CV_i} indicates a qualitative state variable of the valve CV_i .

network of overlapping processes can be observed after a long delay, even when the initial cause has already been removed. Detecting fault in those cases is an active research work. Modeling propagation delays by the clock constraints of the extended qualitative model is currently under investigation.

4.5 Validating Concurrent Fault Hypotheses

A fault hypothesis is any combination of the candidate faults. In experts system literature, the Dempster-Shafer (DS) theory of evidence has been applied to verify the hypotheses [57, 58, 122]. However, DS based methods are useful in situations where the elements comprising the hypotheses are mutually exclusive, and the hypothesis set can be narrowed down by accumulation of evidences. In concurrent fault case the mutual exclusiveness condition may not hold and the validation problem for each observed behavior is selecting a subset of candidate faults that if occurred simultaneously, could produce the observed behavior.

For each qualitative process, there exists a relation holding between a candidate fault and a landmark value of an output (or displayed) variable of that process, derived from DBFs. For instance, for the process P_4 and for the candidate fault (CV_1 clogged), the following relation holds (provided that it is the only fault),

$$(\omega_{CV_1}^2 = 0) \rightarrow [H_{T_2} = H_{T_2}^o] \quad (4.12)$$

The following proposition indicates how such relations can be used to verify a fault hypothesis.

Proposition 4.5.1 (Validating Fault Hypotheses–1) *For a hypothesis composed of a number of concurrent candidate faults and for the processes embodying those faults, if the union of the range of variation of an output or displayed variable is identical to that of the observed behavior for that variable, the fault hypothesis can be considered valid.*

The proof is straightforward: for each variable, each process is responsible for a portion of the behavior, given in terms of landmark values and ranges between the neighboring landmark values, and their union is the possible range of variation. If such a behavior is identical to the observed one. Therefore one can derive that all those faults whose effects lead to such behavior actually exist. Let's test the validity of the fault hypotheses for the candidate faults derived in Section (4.4.3). For the Case 1.1, there are three processes active: P_4 , P_7 and P_9 . Test result of the combinatory faults is given in Table 4.1. For instance, \mathcal{H}_1 is valid. Hypotheses \mathcal{H}_3 , \mathcal{H}_4 and \mathcal{H}_7 are not valid because the ultimate level of material in T_2 decreases which is in contradiction with the observed behavior (4.6). Similarly, \mathcal{H}_2 is not valid because the level increases. \mathcal{H}_5 and

\mathcal{H}_6 are the most interesting cases in which H_{T_2} can have any value between the maximum and minimum allowable levels, i.e. H_{T_2} is *controllable*.

Definition 4.5.1 (Qualitative Controllability) *A qualitative variable is controllable if the union of its ranges of variation for the processes it appears in covers the whole allowable range of variation of that variable.*

Controllability, in qualitative terms, indicates whether a particular behavior can be achieved or not. It implies that a variable can have any behavior between the maximum and minimum range of variation. However, the problem of how the behavior is achievable (precise set points and fine regulation) cannot be answered.

Proposition 4.5.2 (Validating Fault Hypotheses–2) *For a hypothesis composed of a number of concurrent candidate faults and for the processes embodying those faults, if the fault hypothesis leads to controllability of an output or displayed variable, that hypothesis is valid.*

From Proposition 4.5.2 one can derive that \mathcal{H}_5 and \mathcal{H}_6 are also valid hypotheses. Note that \mathcal{H}_1 indicates that three concurrent faults may exist, but \mathcal{H}_5 and \mathcal{H}_6 may narrow them down to one, suggesting that either clogging CV_1 or CV_2 may be an acceptable explanation for the observed behavior of the Case 1.1.

For the case 2.1, the active processes are P_{12} and P_{15} . Test results are given in Table 4.2. The only acceptable hypothesis is

$$\mathcal{H}_3 : (\omega_{CV_4}^2 = 0) \wedge (\omega_{CV_5}^2 = 0) \quad (4.13)$$

This implies that CV_4 and CV_5 are both clogged;

For the case 2.2, the active processes are P_{13} and P_{14} . Test results are given in Table 4.3. Again either $(\omega_{CV_4}^2 = 0)$ or $(\omega_{CV_5}^2 = 0)$ cannot produce the observed behaviors if they are a single fault. But concurrent occurrence of them gives an acceptable explanation for both observed behaviors of the cases 2.1 and 2.2.

4.6 Rule Based Level Qualitative Fault Diagnosis

In rule based level the methods for developing the QC_M rules, generating diagnostic rules, and model based discourse understanding are found useful.

Table 4.1: Test results for fault hypotheses of Case 1.1.

\mathcal{H}_1	: $(\omega_{CV_1}^2 = 0) \wedge (\omega_{CV_2}^2 = 0) \wedge (\omega_{CV_6}^2 = 0)$	
Test	: $[H_{T_2} = H_{T_2}^o]$	(level maintained)
\mathcal{H}_2	: $(\omega_{CV_1}^2 = 0) \wedge (\omega_{CV_2}^2 = 0) \wedge (\omega_{CV_6}^2 = 1)$	
Test	: $[H_{T_2}^o \leq H_{T_2} \leq H_{(T_2)max}]$	(level increased)
\mathcal{H}_3	: $(\omega_{CV_1}^2 = 0) \wedge (\omega_{CV_2}^2 = 1) \wedge (\omega_{CV_6}^2 = 0)$	
Test	: $[H_{(T_2)min} \leq H_{T_2} \leq H_{T_2}^o]$	(level decreased)
\mathcal{H}_4	: $(\omega_{CV_1}^2 = 1) \wedge (\omega_{CV_2}^2 = 0) \wedge (\omega_{CV_6}^2 = 0)$	
Test	: $[H_{(T_2)min} \leq H_{T_2} \leq H_{T_2}^o]$	(level decreased)
\mathcal{H}_5	: $(\omega_{CV_1}^2 = 0) \wedge (\omega_{CV_2}^2 = 1) \wedge (\omega_{CV_6}^2 = 1)$	
Test	: $[H_{(T_2)min} \leq H_{T_2} \leq H_{(T_2)max}]$	(level controllable)
\mathcal{H}_6	: $(\omega_{CV_1}^2 = 1) \wedge (\omega_{CV_2}^2 = 0) \wedge (\omega_{CV_6}^2 = 1)$	
Test	: $[H_{(T_2)min} \leq H_{T_2} \leq H_{(T_2)max}]$	(level controllable)
\mathcal{H}_7	: $(\omega_{CV_1}^2 = 1) \wedge (\omega_{CV_2}^2 = 1) \wedge (\omega_{CV_6}^2 = 0)$	
Test	: $[H_{(T_2)min} \leq H_{T_2} \leq H_{T_2}^o]$	(level decreased)

Table 4.2: Test results for fault hypotheses of Case 2.1.

\mathcal{H}_1	: $(\omega_{CV_4}^2 = 0) \wedge (\omega_{CV_5}^2 = 1)$	
Test	: $[A_{out/T_2} \leq A_{(out/T_2)max}]$	(flow increased)
\mathcal{H}_2	: $(\omega_{CV_4}^2 = 1) \wedge (\omega_{CV_5}^2 = 0)$	
Test	: $[A_{out/T_2} \leq A_{(out/T_2)max}]$	(flow increased)
\mathcal{H}_3	: $(\omega_{CV_4}^2 = 0) \wedge (\omega_{CV_5}^2 = 0)$	
Test	: $[A_{out/T_2} = 0]$	(flow maintained)

An observation shows that in system diagnosis, the same or similar faults may happen frequently [63]. For example, clogging the pressure valve CV_4 , while CV_5 is enabled, is quite common, and the effects of such a fault can be observed by a pressure sensor indicating an increase in the pressure of T_2 . A method for handling similar cases and extract the shallow knowledge for the fast and efficient decision making, is highly appreciated.

In Chapter 3 automatic generation of diagnostic rules, addressing similar faults, from a deep qualitative model was addressed. First, the QD_M is transformed to QC_M . We showed in Chapter 2 the way of developing such models. QC_M serves as the model of the rule-based level of S-R-K. Shallow diagnostic rules are generated automatically from the behavioral rules by QSA . QSA is the reasoning technique in this level (see Chapter 3).

Table 4.3: Test results for fault hypotheses of Case 2.2.

\mathcal{H}_1	:	$(\omega_{CV_4}^2 = 0) \wedge (\omega_{CV_5}^2 = 1)$	
Test	:	$[P_{(T_2)min} \leq P_{T_2} \leq P_{T_2}^o]$	(pressure decreased)
\mathcal{H}_2	:	$(\omega_{CV_4}^2 = 1) \wedge (\omega_{CV_5}^2 = 0)$	
Test	:	$[P_{(T_2)min} \leq P_{T_2} \leq P_{T_2}^o]$	(pressure decreased)
\mathcal{H}_3	:	$(\omega_{CV_4}^2 = 0) \wedge (\omega_{CV_5}^2 = 0)$	
Test	:	$[P_{T_2} = P_{T_2}^o]$	(pressure maintained)

4.7 Situation Assessment

Situation assessment⁴ is verifying the current state of the world. During situation assessment, the existing data base of facts is evaluated against the valid fault hypotheses and updated.

It is assumed that the valid faults add to the data base of already existing facts. A set of facts is preserved and updated (similar to *STRIPS* [41] or *possible worlds* [55]). This is different from the ATMS based diagnosis [29] in the sense that we start with a valid fault hypothesis. In assessment technique, the proposition addressing antecedents or consequences of QC_M rules can be an element of the qualitative data base (QDB). Valid faults are treated as new hypotheses, \mathcal{H} , added to the initially given fact set, \mathcal{F} . Apparently, in the $\mathcal{F} \cup \mathcal{H}$ all the hypotheses must hold but some of the existing facts may not hold any more. Then a complete data base (in the formal logic sense) [24] is generated that satisfies the QC_M rules, and has no contradiction with the hypotheses \mathcal{H} . The idea is preserving the existing facts as much as possible until the point that the inconsistency of the QDB by adding any of the facts can be proved [55]. A consistency checking algorithm compares the hypotheses with the already existing facts, \mathcal{F} , detects the facts that are in conflict with \mathcal{H} , removes them and saves the rest in the unchanged (NC) set. The union of QDB and NC is the new fact set, reflecting what has been affected by faults (QDB set) and what has not (NC set).

$$\mathcal{F} = QDB \cup NC \quad (4.14)$$

⁴ This definition of situation assessment is different from that of Thorndyke, in which situation assessment was used as almost synonym to compiled model based fault detection (see [114]).

Definition 4.7.1 (Complete QDB) *The QDB is complete if having three properties:*

- *Facts in the QDB are not contradictory.*
- *Facts in the QDB satisfy the QC_M rules.*
- *Adding any new fact to the QDB that violates a rule of QC_M , also contradicts an existing fact in the data base.*

The consistency algorithm checks if the negation of any proposition p of \mathcal{H} already exists in the fact set. If so, the $(\neg p)$ will be deleted from \mathcal{F} and the rest are saved in the NC set.

Let's consider a valid fault hypothesis for the example Case 1.1, such as:

$$\mathcal{H} = \{(\Omega_{CV_1} = 0), (\Omega_{CV_2} = 0), (\Omega_{CV_6} = 0)\} \quad (4.15)$$

The fact set \mathcal{F} is given in (3.2). The complete data base satisfying QC_M rules and Definition 4.7.1 is given below:

$$\begin{aligned} QDB = \{ & (\Omega_{CV_1} = 0), (K_2 > 0), (P_{T_1}^o < P_{T_1} \leq P_{(T_1)max}), \\ & (\Omega_{CV_2} = 0), (K_1 = 0), (H_{(T_1)min} \leq H_{T_1} < H_{T_1}^o), \\ & (\Omega_{CV_6} = 0), (F_{out/T_2} = 0), (0 < A_{in/T_1} \leq A_{(in/T_1)max}) \} \end{aligned} \quad (4.16)$$

Consistency checking detects the conflicts between \mathcal{F} and \mathcal{H} ,

$$NC = \{(\Omega_{CV_4} > 0), (\Omega_{CV_5} = 0), (\Omega_{CV_3} > 0), (P_{T_2}^o > P_{T_1}^o)\} \quad (4.17)$$

$QDB \cup NC$ reflects the current state of the world.

This updated data base can explain the outcome of fault propagation. For instance, the answer to the questions such as: "What happens to pressure in T_1 in Case 1.1?", is derived from the data base that includes: $(P_{T_1}^o < P_{T_1} \leq P_{(T_1)max}) \in QDB \cup NC$, indicating that the pressure will increase.

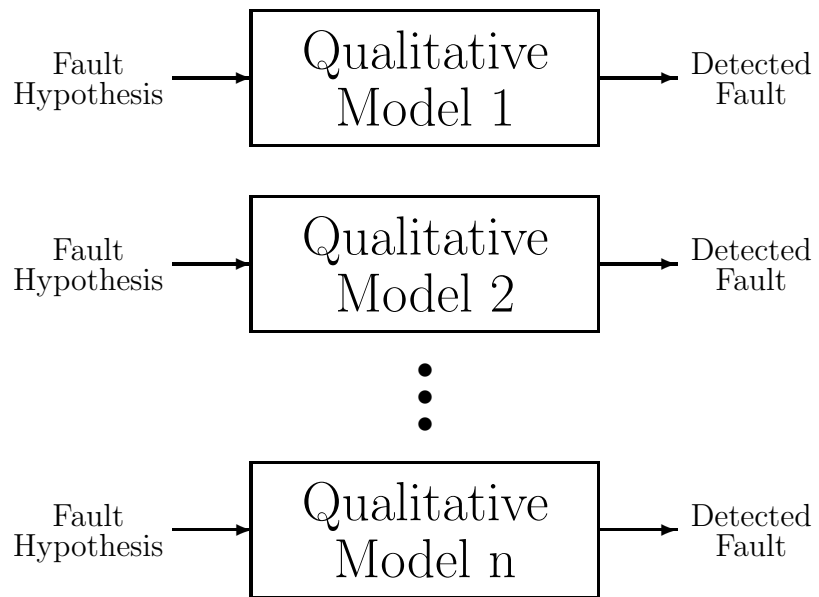

Figure 4.1: Qualitative structure oriented approach to fault diagnosis.

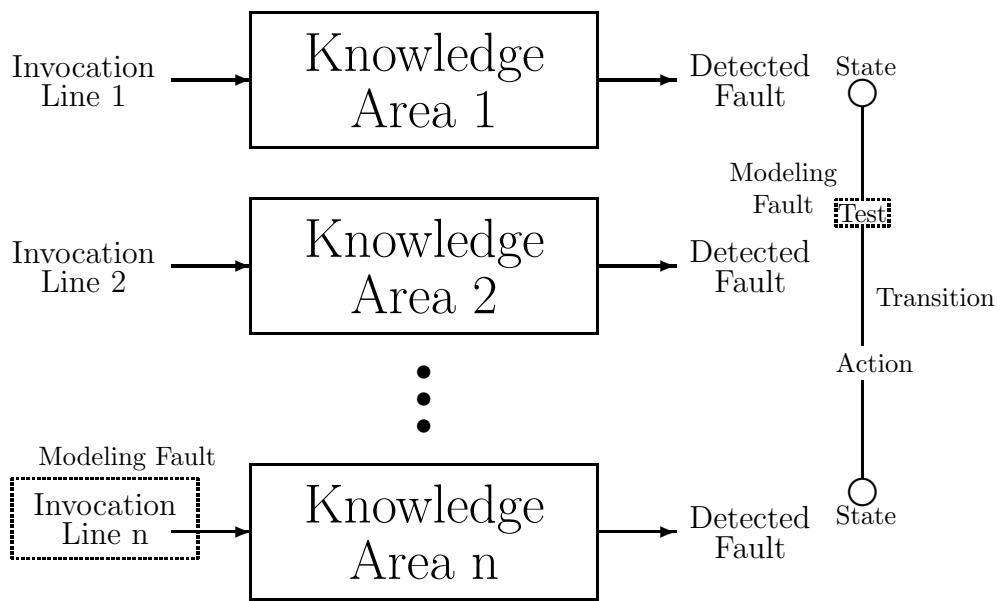

Figure 4.2: Procedure oriented approach to fault diagnosis.

- **Cognitive Overload**
Decision making based on:
 - Large amount of data;
 - Rapid changes of data;
- **Information Accessibility**
Data for decision making is to be inferred along causal chains.
- **Control Directedness**
Initiating actions whose effects are propagated on causal chain to target variables.
- **Counter-intuition**
Limitation in anticipating plant response:
 - Nonlinearities in plant dynamics;
 - Neglecting influence of overlapping processes;
 - Long time delays in system response;

Figure 4.3: Fundamental problems manifesting human performance in fault diagnosis.

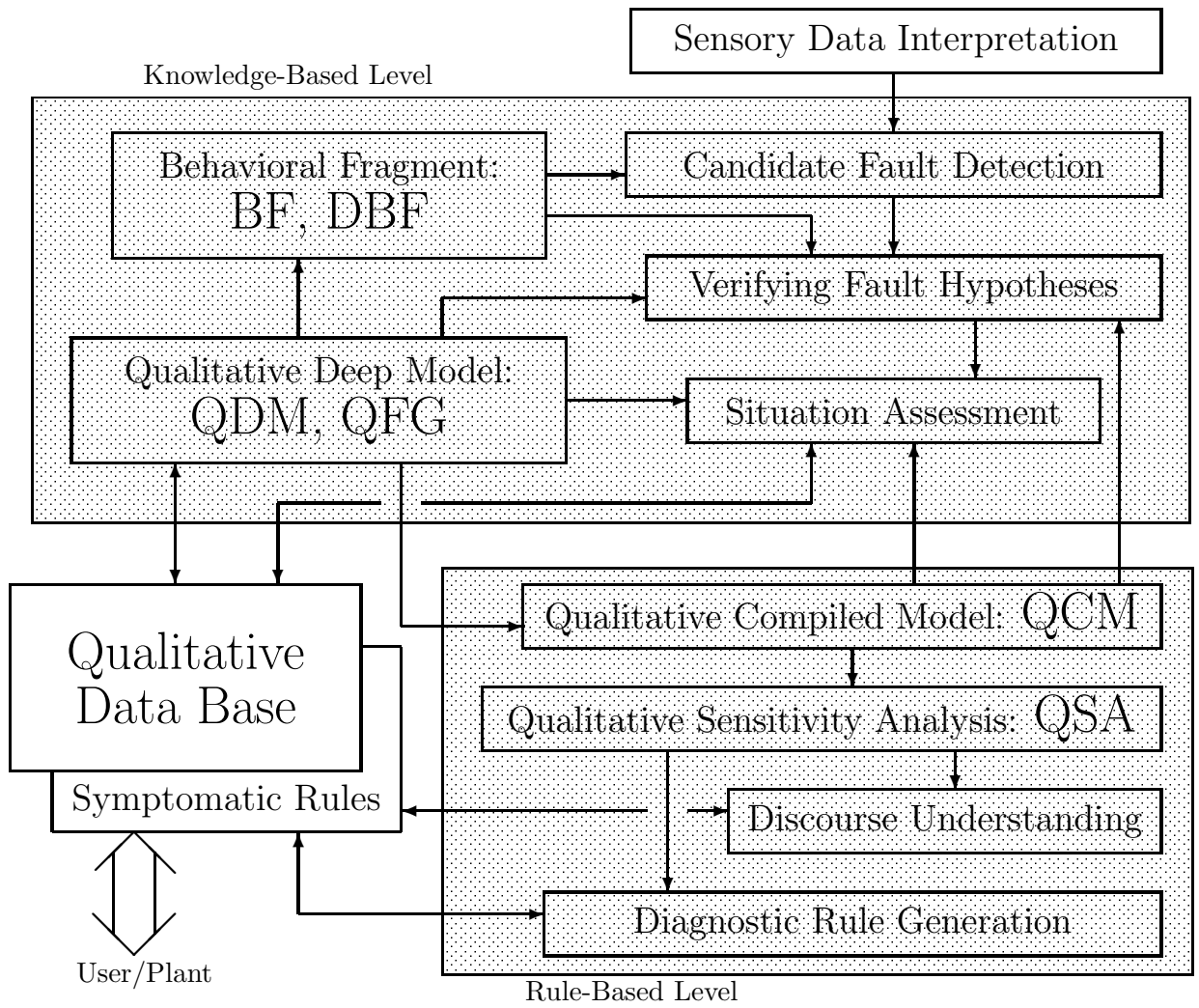

Figure 4.4: Subjective qualitative fault diagnosis system.

Chapter 5

Research on Functional Reasoning: Qualitative Function Formation Technique

5.1 Introduction

Functional Reasoning (FR), in its common sense use, enables people to reason about the presence and function of items¹ in a containing system, derive the purpose of the system and explain how it can be achieved. FR embodies an spectrum of theories and techniques, the definition of which constitutes the subject of this report. FR theories have a representation scheme for describing the items and an inference method for inferring and explaining the items functions and how they can contribute to the functionality of the containing system. A functional reasoning system is composed of a program for functional reasoning, model based simulation, data base and interface tools.

The term *function* has a multilateral spectrum of meanings. Function of a system is usually mentioned along with system *behavior*, *goal* and *purpose*, with respect to system's inner and outer environments [108]. Also it has strong connections with the notion of making efforts to obtain a certain result (mainly when addressing man made objects), a certain future event [11] or to the notion of a *good* (e.g. survival in a natural organism or efficiency for designed artifacts) [109]. In Oxford Dictionary function is defined as an activity by which things fulfill their purpose. In some researches similar definition has been adopted, e.g.:

“...The function of a system is its intended purpose. The functional specification describes the system's goals at a level of abstraction that is of interest at the system level [69].”

In the representational viewpoint of function, which is central in AI, the function of a system is generally addressed with reference to the intention² of humans. In this case *function* and

¹ An item is a simple component or a compound physical object assembled of simple components. A component is the minimum physical building block which cannot be decomposed to other components.

² The term “intention” is used in the narrow sense of a kind of “plan” that includes a representation of the object and its future effects.

behavior of a system are closely related:

“...Function is a relation between the goal of a human user and the behavior of a system. In an assembly, the function of a component relates the behavior of that component to the function of the assembly [12].”

“...Function is the purpose of the system as described by the human user. Function of a system (e.g. electronic circuit) is derived from its behavior and expresses with the technical terms of the domain that it is applied to (e.g. latching, amplification, etc.) [27].”

These latter definitions are guiding functional reasoning research in AI and implemented in functional reasoning systems, e.g. [33, 80].

We have defined function as an interpretation of either a persistence or an order in the sequence of states of the qualitative state vector derived by qualitative simulation and repetition cycle detection.

Although goals and functions share a big portion of their meaning spectrum, the explanation of goal directed behavior includes two distinct components: causal and functional explanations [81].

“... Explanations proposed in connection with goal directed behavior account for the presence of various items in two different ways. One way is the explanation of HOW the goal is realized in terms of assumed capacities of the system’s various organs, the organization of the system’s component parts, and a number of laws concerning the effects produced by the activities of those parts. ... Explanations of this sort are often said to be causal [81].”

Functional explanation accounts for: first, the presence of a component in a system in terms of certain effects it has on that system of which it is a member. Second, functional explanation explains the *purpose* of a system in terms of its structure and behavior or functions of its components.

“... Unlike causal explanations, those of this second type are often said to answer the question WHY at just the place and time it occupies ... by stating certain consequences of the process or structure. Such explanations have traditionally been called teleological [81].”

The first category refers to an explanation of the presence of some component in the system in terms of its contributions or certain effects that the component produces in the system [82], or in terms of some capacity that the component has and contributes to the capacity of the containing system [25]. In the second category the traditional teleological process of *means* and *ends* are identified [4].

Researches under the topic of functional reasoning has not yet been emerged to a definite area of study and they may be viewed as a convergence of several distinct research lines pointing at their problem domain from the functional viewpoint [111]. Research area covered in this report has been studied within a variety of disciplines, including philosophy, biology and computer science; enhanced by the techniques borrowed from computer technology and AI; and the outcomes are applied to different areas such as design, planning and learning. The basic problems are formulated and studied in different ways and there are a number of systems developed

without noticing the pitfalls and drawbacks mentioned elsewhere. On the other hand, theories and techniques applicable to a particular area may not be general enough to be applied to the others.

5.2 Functional Reasoning Problems

5.2.1 Informal Problems

Humans in both daily life and professional experiences are enthralled by tasks requiring reasoning and problem solving through utilization of some kind of functional knowledge and functional reasoning. Traditionally, the followings are considered as the functional reasoning problems within different branches of inquiry.

- *Philosophy*: In philosophy, functional reasoning theories have to find answer to a set of problems, among them the most common ones are explaining why an organ (e.g. heart) is in an organism (e.g. human's body) in terms of its contribution to the functionality of the whole organism. Also it may be required to derive the natural function of an organ (i.e. heart for pumping blood versus making heart sound, etc.). Finally, there is also a class of problems requiring explanations with reference to functions (e.g. why animals in the Arctic have white fur?).
- *Engineering*: In engineering, functional reasoning generally has to differentiate between the means and ends, in order to explain why a component is exploited in a designed artifact in terms of its contribution to the functionality of the whole system.
- *Artificial Intelligence*: Explaining the functions of artifacts, generating understandable and sound explanation of functions with reference to common physical laws is considered as an area of study in AI³. Among possible problem areas, action planning, learning and functional design of artifacts and fault diagnosis fall within the scope of functional reasoning techniques.

5.2.2 Formal Problems

Formally, there are four categories of functional reasoning problems, i.e. identification, explanation, selection and verification. These are defined herewith.

1. *Identification Problem*: Given an object, explaining its function using the knowledge of the structure and behavior of its component and their organization. (e.g. what can a pair of scissors do?)

Typical researches: [50, 27, 67, 113, 30, 33].

³ Qualitative reasoning concentrates on six tasks: simulation, envisionment, building mental models, diagnosis, verification and deducing functionality [12].

2. *Explanation Problem*: Explaining the presence of a component in a containing system in terms of its contribution to the overall function of the system.

Typical researches: [62, 19, 73, 6, 98, 120, 25, 26, 81, 82].

3. *Selection Problem*: Given a set of components, selecting the proper components that if used together can achieve a desired function.

Typical researches: [50, 14, 86].

4. *Verification Problem*: Verifying whether an item can exhibit a required function in a given situation. (e.g. can a given spanner open a given bolt?)

Typical researches: [80, 115].

Functional reasoning problems can be evaluated against the abstraction hierarchy [88, 89]. In dealing with the identification and verification problems, one starts with a representation of structure and ends with a function. Selection, on the other hand, start with a function and end with a physical description of the item. Explanation can proceed in either directions.

5.3 Functional Reasoning Systems

Typical functional reasoning systems vary mainly depending on area of study: common sense reasoning, planning, image understanding, fault diagnosis and computer aided design (CAD), etc.; ontological primitives; representation schemes of structure or functions; initially given data: item's image or a formal description of its physical structure, etc.; and focus of study on particular problems. We classify the functional reasoning systems in two generations and three general categories (see Figure 5.5.5):

- Planning and design systems;
- Explanation based systems;
- Conceptualization systems;

A survey on functional reasoning techniques and systems is given in [39]. Brief surveys of other researches with focus on a certain areas can be found in the followings:

- Conceptualization systems: [113];
- Explanation based systems, qualitative kinematics: [32, 33];
- Diagnosis systems: [101, 43];
- Design systems: [80, 21].

Typical systems focus on three problem domains: functional design and design evaluation of mechanical devices (e.g. [80, 86] and [115]), explaining function of electronic circuits (e.g. [27], etc.) and fault diagnosis (e.g. [42, 43, 101] and [2]). In each domain, identification and characterization of the primitive elements are necessary [86]. Characterization is mainly based on the *main function* of the objects (or components). In electronic circuits, function of components does not change in different configurations, thus a single description of individual components and their function is usually enough. For mechanical devices different configuration of components may be associated with different functions.

All the system reported define a two dimensional representation of structure and functions. An important point called *means-ends decomposition incompatibility* [89, 74] or *nonlinearity of the functions* [80]), is that when using the two dimension structure/behavior (kernel domain space [2]) and function (abstraction space [2]), the two dimensions should be considered as independent and decomposition relation in one dimension cannot be applied to the other one. For instance, if structures S , S_1 and S_2 lead to function F , F_1 and F_2 , respectively, and if F is decomposed to the two functions F_1 and F_2 ($F = F_1 + F_2$), one can neither deduce that $S = S_1 + S_2$, nor S_1 and S_2 can necessarily produce F . The conditions for equivalency of the two dimensions is discussed in [3].

5.3.1 History: Functional Reasoning in Biology and Design

Plato and Aristotle were among the earliest philosophers talking about functions. They described the function of items conferring to some *good*. This idea exists in some researches such as Sorabji's natural functions connected with the notion of good [109], or Canfield's explaining function by its *usefulness* to the containing system [19]. Later philosophers from Spinoza to those of the late 19th century were engaged with explaining the design into nature using teleological notions of *means* and *ends* [4].

Most of the recent functional reasoning theories are either derivations or critical reformulations of the seminal work of Hempel and Nagel [62, 82]. (Among the followers are [73], [6] and [98]). Hempel could provide an analysis of functional ascription in terms of sufficient conditions. Nagel, on the other hand, tried to specify the necessary conditions. These two attempts seemed to be somehow problematic:

“... Any analysis in terms of sufficient conditions may lead to a schema with true premises but invalid, and any formulation specifying necessary conditions may yield to a valid but unsound explanation [25].”

Recently, the unification of functional and causal explanations is the central idea [120, 121]. Cummins argues against the validity of the underlying assumptions of traditional functional explanations and suggested an alternative scheme: functional ascription to an item is ascribing a *capacity* to the item that can be recognized by its role in an analysis of some capacity of a containing system [25]. These theories are reviewed in [39].

Advances in AI and distributed systems have led to new interpretation and implementation of the functional reasoning theories in programs. In typical systems, the initially given data consists of the items, their image or a formal description of the physical structure and behavior of their components. The outcome is describing and explaining the function of the item in terms of the structure or behavior of its components or their functions. These are mainly inspired by the Beckner's theory (first generation systems), Cummins' analytical explanation, Hempel and Nagel's causal/functional explanation of goal directed processes [81] (second generation systems). There is also a shift of attention from justification of the theory to performance evaluation of the implemented systems.

5.3.2 First Generation Functional Reasoning Systems

The first generation functional reasoning systems start with either a formal description of physical structure or description of shape. Also systems starting with natural language instructions have been reported [5]. Figure 5.2 shows the basic building blocks of the first generation systems. They process the input data and relate it to a functional concept already recorded in the data base. The functions in the data base can be symbolic names for a property of a given item and may include some slots filled by the data measured or interpreted from the real world. The first generation systems are efficient in well defined working domains although crippled when facing most of the functional reasoning problems. Their main drawback is the restricted view of the direct list matching inferences. All the items and functions are defined and recorded in the structure-function data base.

5.3.3 Second Generation Functional Reasoning Systems

In second generation functional reasoning systems functional explanation can be derived from a causal account of system's structure and behavior, offering more flexibility through employing a kind of model based reasoning. A number of methods are suggested for the model based approach to assign functions to items [27, 113, 86, 33, 49], etc. Using qualitative simulation to derive the behavior from structure, and causal reasoning to explain how the behavior is achieved, are typical. Interaction with the environment is expressed in the context [113], constraints [27], physical features [80] or connection frames [86].

The second generation systems mostly use heuristic rules for extracting function from the behavior. The Q_{FF} technique does not require any such rules and is a systematic method to extract function from behavior.

5.3.4 Planning and Design Systems

Planning and design (CAD) systems can support the user by providing a planning (design) environment, more useful than detailed planning (geometric design), leading to an increase of the quality and efficiency of planning (design) task. A common limitation of these systems is

that they can only deal with the items falling within their defined symbol set, standing for activities (components). Functional representation and reasoning is accomplished in many different ways. Sembugamoorthy has argued that function can be represented in many dimensions, such as causal, temporal and interaction. In each dimension functional knowledge can have five attributes: structure, specifying relation between components; purpose, specifying what is the response of the device to an stimulus; behavior, specifying how the response is accomplished; generic knowledge, which are chunks of deeper knowledge and specialized versions of physical laws; and assumptions, guiding selection among behavioral alternatives. Purpose clauses are central and are defined with reference to the other four [101].

Murakami et al. has defined function with: (a) transformation between states of physical quantities and substances; (b) physical features that describe the relation between a physical structure and functions indirectly. A physical feature describes characteristic properties of the physical structure (entities, relations, etc.). The function of an assembly is derived as causalities of transformation, using physical features. A physical structure, having a particular physical feature can realize functions connected to that physical feature [80].

Bradshaw et al. has suggested a combination of the qualitative structural description and function of devices. The model is comprised of components and their connections expressed by a number of qualitative variables. Behavior of the device is generated using the qualitative model. Functional description is separate from the structural description, and within the structural description an identifier links the structure to defined purposes (functions). The purpose has a *what* and a *when* clause. The *what* describes the purpose in terms of a certain landmark value of a variable (e.g. temperature: normal), while *when* specifies conditions for achieving the particular purpose [13].

Pu et al. has proposed a representation framework for structure and function of devices by a network of component and connection frames, using a finite set of generic components and connections. The component frame describes a component. Within a component frame, the component's local behavior is described by a collection of methods (rules) specifying the current state, input expected, output component and next state. Every pair of components are addressed by a connection frame describing how the motion and forces are propagated between them. In a connection frame, methods are rules describing propagation of behavior between components. Each method has current state, input expected and output to slots. This knowledge is used to simulate the device behavior. First an input component (one receiving external force or energy) is selected, its local behavior is identified using the component frame, and the effects are propagated to the neighboring components using the connection frames. here the connection between components is the kernel for functionality. Compared to Murakami's, here the connection frames replace the physical features [86].

5.3.5 Explanation Based Systems

Traces of qualitative reasoning in explaining function of items can be found along with the three major theories of qualitative physics, i.e. the qualitative process theory [45] influenced deriving function for mechanical devices using geometric data (see [33]), qualitative confluence theory [28] has influenced explanation of function of electronic circuits using mechanism graphs and teleological analysis (see [27]) and qualitative simulation [71] has led to explaining function of designed artifacts using scenarios and partial states (see [49]). The above scenarios have two main drawbacks: dependability on modeling viewpoint and poor in identifying mechanisms that take part in forming a function concept.

In the seminal work of Dekleer, a theory of teleology for physical devices was proposed [27]. Teleology relates behavior to function. First a causal account of behavior of the system is produced from its physical structure using causal analysis, then behavior is related to the functions of the device through mechanism graphs (MG) and teleological analysis (TA). Mechanism graphs have explicit notation of some of the components⁴. Each of those components characterizes a portion of the MG composed of connected edges and vertices. Teleological analysis can describe the role or function of those component as contributing to the functioning of the whole device. More specifically, for each component of the device and for each configuration of the component in the MG, there exists a term (word or symbol), such that it can describe the function of the component as seen in the view of the contribution to the device's function.

Forbus and Faltings have proposed ways of finding description of behavior of mechanical assemblies based on geometry of components. In Faltings' [32, 33] a basic assumption is that contacts between the component pair will lead to their functionality. Each component is described by a number of parameters for its position and orientation. The space of parameters is called *configuration space* (CS). A point in CS is a configuration. It is assumed that a contact configuration defines a place and points in one place are considered equivalent in the understanding of mechanisms. Regions of the CS having the same kinematic state and the same qualitative inference rule are called *places*. Interesting points in CS are those that define a contact. For higher kinematic pairs, with one degree of freedom for each, two parameters are sufficient to define the configuration plane and places are visualized by regions in this plane. As each contact reduces the dimension of the space by one, then lines in this plane represent one point contacts and vertices denote two point contacts. Joskowicz's method is similar to Faltings' in terms of finding description of behavior of mechanical devices based on geometry of parts, using the idea of kinematic pair. However, the idea of representing paired relation by a constraint network is new. In the constraint propagation network each component is represented by a node and paired relation by a constraint edge between two nodes. Explanation is accomplished in two steps. First, the local interaction analysis starts with a geometrical description of devices and finds possible relative motions of all pairs in contact. Relative motions are expressed in terms

⁴ Components that only participate in local feedback loops do not explicitly appear in the mechanism graph.

of a small set of parametric motion predicates and a set of algebraic relations between parameters. Then the global interaction analysis starts with the given relative motions and an input motion, and derives the actual behavior for each device, using constraint propagation and label inferential technique [67, 68].

Franke et al. has developed a language for qualitative teleological description of designed devices that describes function in terms of behaviors prevented, guaranteed or introduced by the components. It adds the *partial state* and *scenario* to the variable, state and behavior terminology, that are common in qualitative techniques. Partial state is a generalized version of state and scenario is a sequence of partial states. Primitive teleological operators (i.e. Guarantee, Prevent and Conditionally) are defined for modifying scenarios [49].

Bylander's consolidation uses somewhat different modeling primitives. It is assumed that the interaction among components of a device is due to the *stuff* or substances which are transferred between components and affect their behavior. The function of the components is what they can do with that stuff. Bylander presents an ontology for structure and defines a set of component behaviors (see Table 5.1). In consolidation, two components are selected and the behavior of the pair is derived from the behavior of the individual components [16, 17]. Given a description of behavior, consolidation can lead to explaining why components are in the object and how they contribute to the overall functionality.

There is an analogy between the explanation based functional reasoning systems and explanation based learning (EBL) techniques [31]. The above methods each resemble a kind of EBL using either chunking or generalization. Identifying primitive fragments on the Dekleer's mechanism graph resembles chunking, and teleological analysis seems to be a kind of EBL using qualitative data (derived by qualitative simulation based on confluences) as its input sequence. Similarly, identifying *places* in Faltings' resembles chunking, using metric diagrams as the input sequence. Finally, Franke's partial ordering of states from the simulated behavior is a kind of generalization in EBL using qualitative data (derived by the QSIM method) as its input sequence.

Functional knowledge constitutes a big part of the human experts' reasoning and explanation in fault diagnosis, therefore systems capturing and retaining such knowledge are emerged. Abuhanna et al. has defined three model-knowledge classes: kernel domain space that maps to the physical world and include the physical structure and behavior; abstraction space that includes functional knowledge, which is associated to the behavioral abstraction; and finally, the use space in which knowledge corresponds to the objects use in the user's terms. Graph representation is exploited for the abstraction space. Nodes are functions. Each function has at least one parameter. Arcs correspond to parameters. The result is called *functional design model*. In fault diagnosis, each node of the model is attached with some observable attributes. An observed behavior can trigger some of the nodes whose attributes are activated or disabled. Those functions are then interpreted in the other levels of abstraction to locate the exact cause

of malfunctioning [2].

Fink et al. has introduced an integrated fault diagnosis system (IDM) using shallow (experimental) and deep (physical and functional) knowledge. The shallow system has the knowledge of the symptom–cause form. In the deep level the model includes representation of structures and functions. A number of domain dependent functional primitives are defined, such as transforms, regulator, reservoir, conduit and joint. System behavior can be simulated using these primitives. Functions are assigned to components by the system designer. Each component (or a collection of components) is called a functional unit. In the deep level, faulty behavior can be detected by examining the inputs and outputs of functional units. The system can check if the enabling conditions for each functional unit is violated or not [42, 43]. Functional primitives resemble those exploited by Kueneker or Bylander (see below) and domain dependency of the functional primitives limits the generality of the method.

5.3.6 Conceptualization Systems

There are some methods (e.g. [103, 16, 113, 69] and [35]) suggesting a hierarchical classification scheme for functional concepts; defining classes objectively; and aggregating objects into the classes [44]. The hierarchy may be represented by conceptual dependency graphs [103] or temporal graph [102]. The class types are defined by *functional primitives*. The functional primitives of the above methods are summarized in Table 5.1. The sufficiency of such a set is discussed [69], but still the necessity and sufficiency of the primitives, and whether they are appropriate for functional representation (in terms of means–ends hierarchy [89, 91]) is somehow doubtful.

Table 5.1: Functional primitives.

SHANK 77 [103]	: <i>ATRANS, PTRANS, PROPEL, GRASP, INGEST,</i> <i>EXPEL, MOVE, DO;</i>
BYLANDER 88 [17]	: <i>ALLOW, PUMP, EXPEL, MOVE, CREATE, DESTROY;</i>
TEZZA 88 [113]	: <i>SUPPORT, GRASP, ENTER, CONTAIN, HANG, CUT,</i> <i>PIERCE, EQUILIBRIUM, STOP, PLUG;</i>
KEUNEKE 91 [69]	: <i>ToMake, ToMaintain, ToPrevent, ToControl;</i>
FAR 91 [35]	: <i>PTRANS, ATRANS, GRASP, ROTATE, PROPEL,</i> <i>RELEASE, STEP-UP, STEP-DOWN;</i>

Most of the methods do not allow deriving new functions of objects other than those coded in the data base. Every new assumption may affect the whole data structure. Checking completeness and consistency of the representation is not a trivial task. A main problem is that

all the above mentioned method try to define the primitives objectively: assign meaning to the behavior of the objects at the first place, and then recover it as a function. QF_F is the only technique that can derive regularities in behavior without ascribing any meaning to it, and define function in terms of such regularities.

5.4 Qualitative Function Formation Technique

5.4.1 Basic Assumptions

A physical phenomena can, in principle, be explained in terms of *histories*⁵ [59, 61] and *episodes*. Episodes are temporal slices of a history [60]. State is an episode of very short duration. A basic feature of an state is that it assigns a certain characteristic to its referred component pair [75], therefore it is possible to define function concepts with reference to discovery of an order in the state sequence. In our thesis, history, state and function are defined and explained based on the following assumptions.

Functionality in Item Pair:

There is a question concerning whether function resides in an object (or its components) or it is an outcome of the interaction between objects (or two components). At the first glance it seems that humans have a data base in which the objects are associated with several functionalities. Some of the theories and systems have taken for granted that function is a property of its source object. Perhaps this is one of the sources of difficulty in both logical formulation (see for instance [120]) and actual implementation (see [113], etc., for systems based on this assumption). Some others argue that function can be ascribed to a pair (see for instance [33, 67, 46]). In terms of histories of individual objects and states, it is almost impossible to explain how different functions can be attached to a single object. We adopt the *functionality in item pair (FIP)*⁶ as a central assumption, stating that the at least a pair of objects (or components) are required to interact functionally and function concepts can be derived from their combined histories.

Functionality in State Transition:

Intuitively, the history that leads to a function should display a certain pattern [11]. States, in the sense defined above, are useful to extract those patterns and define functional concepts: Actually, a functional concept is the result of interpreting a persisted state or a discovery of an order in the sequence of states. In biological systems persistence is perhaps the most interesting

⁵ We use the term "history" in a sense slightly different from that of Hayes, where some variables of interest may replace or be added to the three dimensional spatial coordinates.

⁶ Close or similar ideas are mentioned also by the Locality of Histories [61], Connectivity Hypothesis [46] and Pairwise Interaction of Parts [33].

characteristic and is believed to be governed by natural selection law. In designed artifacts other kinds of *order* may also be appreciated.

A functional reasoning technique based on these assumptions has many advantages: first, the problem of indexing and mapping from behavior to functions can be removed. Second, it provides a framework for comparing and evaluating functions of systems with different structures. Finally, it can explain the existence of a certain component in a system in terms of its contribution to persistence or a desired order in the containing system's behavior. The Q_{FF} technique is based on these assumptions.

5.4.2 Overview

Generally, any system's structure can be viewed as an organization of finite number of interacting component pairs. Each pair is modeled by a set of expressions relating qualitative variables and qualitative operations. Each expression of this form embodies the humans' understanding of objects interaction. This is called modeling with reference to conscious observer.

Theoretically every two components may be paired, however among all possible interactions, in each case only a limited number of them are actually coded in the model (see Figure 5.3). The models of the component pairs are joint together and represented by a graph, Q_{FG} , showing the viewpoint from which the model is developed. Q_{FG} depicts interactions expressed by physical laws as well as interactions representing a kind of coordination, coded by temporal and dependency constraints. The model embodies qualitative processes. Processes can *compete* and *cooperate* to realize the system's overall function. Each process relates a characteristic feature of the component pair to the effects they have on the system. Such effects are described by Behavioral Fragments (BFs). The behavior of the pair is given by the history of the qualitative state vector which consists of the landmark values of the variables appearing in BFs of the activated processes.

A function concept, for a system embodying a number of qualitative processes, can be expressed in terms of:

- Operationality, i.e. activated processes and their enabling conditions, given by the temporal and dependency constraints.
- Repetition cycle (i.e. persistence or an order) in the trace of the qualitative state vector.

Figure 5.5.5 shows an overview of the Q_{FF} technique. In Fig 5.5 an example of the windows of the system is given. Although the technique is general, the focus is on designed artifacts with lumped components rather than natural systems. The reason is that in man made systems the boundaries of the system itself is clearly defined and interaction of the components are understood from an engineering–scientific perspective. Therefore coordination and interactions among the components are governed by well understood physical laws and/or standard communication protocols.

5.4.3 Detecting Repetitions in Behavior

The repetition cycle is derived for the variables of the qualitative state vector. Qualitative state vector for a component pair is composed of the landmark values of the BFs for displayed qualitative variables of the active processes that model the pair. History is the trace of the qualitative state vector, for example,

$$H = \left\{ \begin{array}{ccccc} t = 1 & t = 2 & t = 3 & t = 4 & \dots \\ L_X^1 & L_X^2 & (L_X^3 - L_X^4) & \perp & \dots \\ L_Y^1 & \perp & L_Y^2 & (L_Y^3) & \dots \\ L_Z^1 & \perp & \perp & (L_Z^2 - L_Z^2) & \dots \end{array} \right\} \quad (5.1)$$

where H is the history, and t depicts the time instants, [X], [Y] and [Z] are qualitative variables; L_X^i is the ith landmark value of the variable [X]; and $(L^i X - L_X^{i+1})$ shows an interval bounded by two landmark values; \perp indicates that the variable is not present.

Figure 5.5.5 shows the algorithm for detecting the repetition cycle. Note that different cycles for different variables can possibly be detected. Each cycle may represent a functional concept from a different viewpoint. If the cycle for all the variables is identical, then a unique function for the pair is derivable.

Again some other researches show more interest in *eventuality* of a certain process⁷. Detecting the repeating cycle and finding out what will be the outcome of repetition of the cycle is what constitutes the aggregation theory [118]. We are more interested in finding the eventual outcome for a single, as well as a number of cooperating and competing processes. The constraints on the way processes can cooperate or compete has a strong influence on the final outcome.

5.5 Design Verification Using Qualitative Function Formation

Conventional computer aided design (CAD) systems provide an environment for detailed design and the more intuitive activities of design, i.e., those related to functional design, are to be handled by the designer. Basically, functional design is not just a direct transformation between goal specification and the designed object in physical terms, but it requires iteration between considerations at various levels [88]. Such iteration may be timely and complicated for the human designer and can be conveniently shared between the CAD system and the designer. In doing so, the complementary role of structures and functions in design should be expressed by a unified theory [110]. QFF is a method for linking function to structure. In functional design the initially given information are [39]:

- A desired function f for the designed artifact;

⁷ What we call "process" is referred to as a repeating cycle by Weld. In his terms, a cycle is simply "a collection of processes which can independently repeat activity", and he refers to a process as a kind of rule with preconditions and actions [118].

- A menu of design preferences, including the decomposition of f into a number of other functions, $f_1 \dots f_n$;
- Specification embodying components' interactions and design constraints;

Specification and preferences are described qualitatively, using the extended qualitative modeling technique, introduced above. Qualitative simulation and QFF can lead to: arrangement of components necessary to fulfil f (i.e. selection problem), and possible deletion of redundant components; identifying function of the design artifacts (i.e. identification problem); explaining why a component is exploited in the design (i.e. explanation problem); and verifying that the designed artifact achieving the desired function (verification problem). These are explained with an example system shown in Figure 2.5.

5.5.1 Identification of Functions

In function identification each component pair of the system is modeled and the function of each pair as well as the function of the whole system is derived from their model. Let's consider a portion of the system, shown in Figure 2.5, composed of two valves CV_1 and CV_3 and the tank T_1 . This example is used basically to make the underlying concepts concrete and clear. There are three object pairs: (CV_1, T_1) , (CV_3, T_1) and (CV_1, CV_3) . The relation between (CV_1, T_1) as well as (CV_3, T_1) is constrained by rules of flow and conservation,

$$\begin{aligned}
 (CV_1, T_1) & : [F_1] = [G_1] = M^+[\Omega_{CV_1}] \quad 'when' \quad (\Omega_{CV_1} > 0) \\
 & \quad [F_{in/T_1}] = M^+[G_1] \quad 'when' \quad (\Omega_{CV_1} > 0) \\
 (CV_3, T_1) & : [U_2] = [K_2] = M^+[\Omega_{CV_3}] \quad 'when' \quad (\Omega_{CV_3} > 0) \\
 & \quad [F_{out/T_1}] = M^+[U_2] \quad 'when' \quad (\Omega_{CV_3} > 0) \\
 (CV_1, CV_3, T_1) & : [F_{T_1}] = M^+[F_{in/T_1}] + M^-[F_{out/T_1}] \\
 & \quad [H_{T_1}] = I^+[F_{T_1}]
 \end{aligned} \tag{5.2}$$

$[F_1]$, $[G_1]$, $[U_2]$ and $[K_2]$ stand for the flow-in and flow-out for the valves CV_1 and CV_3 ; $[F_{in/T_1}]$ and $[F_{out/T_1}]$ are material flow-in and flow-out for T_1 ; $[F_{T_1}]$ is the net flow and $[H_{T_1}]$ is the level of material in T_1 ;

Clock constraints:

$$\begin{aligned}
 f_1^2 = g_1^2 & = \omega_{CV_1}^2 (-\omega_{CV_1} - \omega_{CV_1}^2) \\
 f_{in/T_1}^2 & = g_1^2 (-\omega_{CV_1} - \omega_{CV_1}^2) \\
 u_2^2 = k_2^2 & = \omega_{CV_3}^2 (-\omega_{CV_3} - \omega_{CV_3}^2) \\
 f_{out/T_1}^2 & = u_2^2 (-\omega_{CV_3} - \omega_{CV_3}^2) \\
 (f_{T_1}^2 & = f_{in/T_1}^2) \text{ or} \\
 (f_{T_1}^2 & = f_{out/T_1}^2) \\
 h_{T_1}^2 & = f_{T_1}^2
 \end{aligned} \tag{5.3}$$

Dependency constraints:

$$\begin{aligned}
 \omega_{CV_1}^2(-\omega_{CV_1} - \omega_{CV_1}^2) & : [\Omega_{CV_1}] \rightarrow M^+ \rightarrow [G_1] \\
 \omega_{CV_3}^2(-\omega_{CV_3} - \omega_{CV_3}^2) & : [\Omega_{CV_3}] \rightarrow M^+ \rightarrow [U_2] \\
 g_1^2(-\omega_{CV_1} - \omega_{CV_1}^2) & : [G_1] \rightarrow M^+ \rightarrow [F_{in/T_1}] \\
 u_2^2(-\omega_{CV_3} - \omega_{CV_3}^2) & : [U_2] \rightarrow M^+ \rightarrow [F_{out/T_1}]
 \end{aligned} \tag{5.4}$$

The QFG for this system is shown in Figure 5.5.5. Behavior of the component pairs can be derived, for a given initial setting, using qualitative simulation and clock and dependency constraints. For the pair (CV_1, T_1) , assuming that $(\Omega_{CV_1} > 0)$ and $(\Omega_{CV_3} = 0)$, from the clock constraints one can derive that.

$$h_{T_1}^2 = f_{T_1}^2 = f_{in/T_1}^2 = f_1^2 = g_1^2 = 1 \tag{5.5}$$

$$f_{out/T_1}^2 = u_2^2 = k_2^2 = 0 \tag{5.6}$$

The only active process is P_2 with the following BF:

$$\begin{aligned}
 & BF_{P_2} : \\
 & \{(\Omega_{CV_1} > 0) \rightarrow (F_{T_1} > 0) \rightarrow \\
 & (H_{T_1}^o < H_{T_1} \leq H_{(T_1)max}) \rightarrow (H_{T_1} = H_{(T_1)max})\}
 \end{aligned} \tag{5.7}$$

This implies that the level of material in the tank will increase up to the maximum allowable level. The function of the pair (CV_1, T_1) can be derived using the cycle detection algorithm. Clearly the persistence in the level of material in the tank is detectable, therefore, the function of this pair is to maintain the level at the $H_{(T_1)max}$, that may be called *FULL*. Note that the term *FULL* is just a reference term, whose functionally relevant meaning is described by the landmark value $H_{(T_1)max}$ for the pair.

$$FULL : H_{T_1} = H_{(T_1)max} \tag{5.8}$$

Similarly for the pair (CV_3, T_1) assuming that $(\Omega_{CV_3} > 0)$ and $(\Omega_{CV_1} = 0)$, one can get to $(h_{T_1}^2 = f_{T_1}^2 = f_{out/T_1}^2 = u_2^2 = k_2^2 = 1)$ and $(f_{in/T_1}^2 = f_1^2 = g_1^2 = 0)$ for the clock constraints and the active process is P_1 with the BF,

$$\begin{aligned}
 & BF_{P_1} : \\
 & \{(\Omega_{CV_3} > 0) \rightarrow (F_{T_1} < 0) \rightarrow \\
 & (H_{(T_1)min} \leq H_{T_1} < H_{T_1}^o) \rightarrow (H_{T_1} = H_{(T_1)min})\}
 \end{aligned} \tag{5.9}$$

Implying that the level of material in the tank will decrease till the minimum level and the function of this pair is to make the tank *EMPTY*, described by,

$$EMPTY : H_{T_1} = H_{(T_1)min} \quad (5.10)$$

When two processes can simultaneously cause the state transition to different states, in order to determine which one may happen first, some additional timing constraints must be included in the model. When deriving the function of the overall system with both valves opened, i.e., ($\Omega_{CV_3} > 0$) and ($\Omega_{CV_1} > 0$), it is visible that the variable H_{T_1} can possibly have any value within the whole range of variation ($H_{(T_1)min} \leq H_{T_1} \leq H_{(T_1)max}$) without necessarily sticking to either and the overall function of the system is ambiguous. The reason is that the interactions between some of the component pairs, such as (CV_1, CV_3), is not constrained. Imposing constraints on such pairs may lead to a definite function. Those constraints are selected as a design preference, fulfilling a goal of the designer, rather than being governed by a physical law. QFF selects from the menu of design preferences and identifies the function of the system. Some design preferences are given below.

5.5.2 Case 1. Design Preference for Safety: Fault Diagnosis

The designer may have the goal that the system should respond to some possible faults, such as CV_1 clogged. The qualitative model is similar to (5.2), (5.3) and (5.4), with an additional default expression:

$$\begin{aligned} [F_1] = [G_1] &= M^+[\Omega_{CV_1}] && \text{'when'} && (\Omega_{CV_1} > 0) \\ [F_{in/T_1}] &= M^+[G_1] && \text{'when'} && (\Omega_{CV_1} > 0) \\ [U_2] = [K_2] &= M^+[\Omega_{CV_3}] && \text{'when'} && (\Omega_{CV_3} > 0) \\ [F_{out/T_1}] &= M^+[U_2] && \text{'when'} && (\Omega_{CV_3} > 0) \\ [F_{T_1}] &= M^+[F_{in/T_1}] && \text{'default'} && M^-[F_{out/T_1}] \\ [H_{T_1}] &= I^+[F_{T_1}] \end{aligned}$$

Clock constraint:

$$\begin{aligned} f_1^2 = g_1^2 &= \omega_{CV_1}^2(-\omega_{CV_1} - \omega_{CV_1}^2) \\ f_{in/T_1}^2 &= g_1^2(-\omega_{CV_1} - \omega_{CV_1}^2) \\ u_2^2 = k_2^2 &= \omega_{CV_3}^2(-\omega_{CV_3} - \omega_{CV_3}^2) \\ f_{out/T_1}^2 &= u_2^2(-\omega_{CV_3} - \omega_{CV_3}^2) \\ f_{T_1}^2 &= f_{in/T_1}^2 + f_{out/T_1}^2(1 - f_{in/T_1}^2) \\ h_{T_1}^2 &= f_{T_1}^2 \end{aligned}$$

Dependency constraints:

$$\begin{aligned} \omega_{CV_1}^2(-\omega_{CV_1} - \omega_{CV_1}^2) &: [\Omega_{CV_1}] \rightarrow M^+ \rightarrow [G_1] \\ \omega_{CV_3}^2(-\omega_{CV_3} - \omega_{CV_3}^2) &: [\Omega_{CV_3}] \rightarrow M^+ \rightarrow [U_2] \\ g_1^2(-\omega_{CV_1} - \omega_{CV_1}^2) &: [G_1] \rightarrow M^+ \rightarrow [F_{in/T_1}] \\ u_2^2(-\omega_{CV_3} - \omega_{CV_3}^2) &: [U_2] \rightarrow M^+ \rightarrow [F_{out/T_1}] \\ f_{in/T_1}^2 &: [F_{in/T_1}] \rightarrow M^+ \rightarrow [F_{T_1}] \\ f_{out/T_1}^2(1 - f_{in/T_1}^2) &: [F_{out/T_1}] \rightarrow M^- \rightarrow [F_{T_1}] \end{aligned}$$

The QFG in this case is shown in Figure 5.5.5. Let's consider the case that CV_1 is opened ($\Omega_{CV_1} > 0$). In clock terms it means that ($\omega_{CV_1} = 1$). Using clock constraints, one can derive that ($f_{in/T_1}^2 = 1$) and ($h_{T_1}^2 = f_{in/T_1}^2$). Active arcs of the QFG due to dependency constraints are those of P_2 and simulation generates the BF_{P_2} . It follows that the function of the whole system is to make the tank FULL, finally.

If $[F_{in/T_1}]$ is not present (due to a fault making CV_1 clogged), then ($f_{in/T_1} = 0$) and ($h_{T_1}^2 = f_{out/T_1}^2$). On QFG , the arc ($[F_{in/T_1}] \rightarrow M^+ \rightarrow [F_{T_1}]$) is not active any more, but ($[F_{out/T_1}] \rightarrow M^- \rightarrow [F_{T_1}]$) becomes active, instead. Now the process P_1 is responsible for the behavior and simulation generates the BF_{P_1} . Similar argument shows that the system functions as making the tank become EMPTY.

5.5.3 Case 2. Design Preference for Safety: Safety Margin

The designer may want to limit the level of material in the tank for safety purposes. The qualitative model for the same system including this constraint is:

$$\begin{array}{llll}
 B & = & (H_{(T_1)crtl} \leq H_{T_1}) & \\
 [F_1] = [G_1] & = & M^+[\Omega_{CV_1}] & \text{'when' } (\Omega_{CV_1} > 0) \\
 [F_{in/T_1}] & = & \{M^+[G_1] & \text{'when' } (\Omega_{CV_1} > 0)\} \text{ 'until' } B \\
 [U_2] = [K_2] & = & M^+[\Omega_{CV_3}] & \text{'when' } (\Omega_{CV_3} > 0) \\
 [F_{out/T_1}] & = & M^+[U_2] & \text{'when' } B \\
 [F_{T_1}] & = & M^+[F_{in/T_1}] & + M^-[F_{out/T_1}] \\
 [H_{T_1}] & = & I^+[F_{T_1}] &
 \end{array}$$

$H_{(T_1)crtl}$ is the critical value for the level of water in the tank. Obviously,

$$H_{(T_1)crtl} \leq H_{(T_1)max} \tag{5.11}$$

Clock constraints:

$$\begin{array}{ll}
 f_1^2 = g_1^2 & = \omega_{CV_1}^2(-\omega_{CV_1} - \omega_{CV_1}^2) \\
 f_{in/T_1}^2 & = g_1^2(-\omega_{CV_1} - \omega_{CV_1}^2)(-b) \\
 u_2^2 = k_2^2 & = \omega_{CV_3}^2(-\omega_{CV_3} - \omega_{CV_3}^2) \\
 f_{out/T_1}^2 & = u_2^2(-b - b^2) \\
 (f_{T_1}^2 & = f_{in/T_1}^2) \text{ or} \\
 (f_{T_1}^2 & = f_{out/T_1}^2) \\
 h_{T_1}^2 & = f_{T_1}^2
 \end{array}$$

Dependency constraints:

$$\begin{array}{llll}
 \omega_{CV_1}^2(-\omega_{CV_1} - \omega_{CV_1}^2) & : & [\Omega_{CV_1}] & \rightarrow M^+ \rightarrow [G_1] \\
 \omega_{CV_3}^2(-\omega_{CV_3} - \omega_{CV_3}^2) & : & [\Omega_{CV_3}] & \rightarrow M^+ \rightarrow [U_2] \\
 f_{in/T_1}^2 & : & [G_1] & \rightarrow M^+ \rightarrow [F_{in/T_1}] \\
 u_2^2(-b - b^2) & : & [U_2] & \rightarrow M^+ \rightarrow [F_{out/T_1}] \\
 f_{out/T_1}^2 & : & [F_{out/T_1}] & \rightarrow M^- \rightarrow [F_{T_1}]
 \end{array}$$

The Q_{FG} in this case is shown in Figure 5.5.5. When the condition B is false ($b = -1$), indicating the critical level is not achieved yet, then ($f_{out/T_1}^2 = 0$) and the arc ($[U_2] \rightarrow M^+ \rightarrow [F_{out/T_1}]$) cannot be active. Therefore, only P_2 is responsible for the behavior and simulation shows that the level in the tank increases until B becomes true. When the condition B is true ($b = 1$), indicating the critical level is passed, then ($f_{out/T_1}^2 = u_2^2$) and the arc ($[U_2] \rightarrow M^+ \rightarrow [F_{out/T_1}]$) becomes active and P_2 is not active any more because ($f_{in/T_1}^2 = 0$). Therefore P_1 ensures that level will decrease until the critical condition is violated again. The behavior in this case is (see Figure 5.5.5):

$$\begin{aligned}
 H_{T_1} = & \\
 & H_{T_1}^o, H_{(T_1)crtl}, H_{(T_1)crtl} \leq H_{T_1}, \\
 & H_{(T_1)crtl}, H_{T_1} \leq H_{(T_1)crtl}, H_{(T_1)crtl}, \dots
 \end{aligned} \tag{5.12}$$

($H_{(T_1)crtl} \leq H_{T_1}$) and ($H_{T_1} \leq H_{(T_1)crtl}$) are landmark values on the next immediate time instant after the level passes the critical value. Using the cycle detection algorithm, one can derive the following cycle in behavior:

$$H_{(T_1)crtl}, H_{(T_1)crtl} \leq H_{T_1}, H_{(T_1)crtl}, H_{T_1} \leq H_{(T_1)crtl}, H_{(T_1)crtl} \tag{5.13}$$

This implies that the behavior swings around the $H_{(T_1)crtl}$. One can call this cycle *MAINTAIN*. The function of this arrangement is to maintain the level around $H_{(T_1)crtl}$.

5.5.4 Explanation of Functions

The reason for a component being selected to be a part of the design is explained in terms of its contribution to the functionality of the design. In explanation, the effects of individual components on the system should be identified. Qualitative processes and BFs are found useful. The simulated behavior of the processes exhibits the way the components contribute to the functionality of the system.

Let's consider the system of Figure 2.5 and explain the why a given control valve, such as CV_2 , is exploited in this design. The pressure valve CV_2 appears in three processes P_3 , P_4 and P_5 (see Figure 2.5). Their behaviors are:

$$\begin{aligned}
 BF_{P_3} = & \\
 & \{[\Omega_{CV_2} : 0, (\Omega_{CV_2} > 0)], [U_1 : 0, (U_1 > 0)], \\
 & [F_{out/T_2} : 0, (0 < F_{out/T_2} \leq F_{(out/T_2)max})]\}
 \end{aligned} \tag{5.14}$$

$$BF_{P_4} =$$

$$\{[\Omega_{CV_2} : 0, (\Omega_{CV_2} > 0)], [U_1 : 0, (U_1 > 0)], [H_{T_2} : H_{T_2}^o, (H_{(T_2)min} \leq H_{T_2} < H_{T_2}^o)]\} \quad (5.15)$$

$$BF_{P_3} = \{[\Omega_{CV_2} : 0, (\Omega_{CV_2} > 0)], [U_1 : 0, (U_1 > 0)], [K_1 : 0, (K_1 > 0)]\} \quad (5.16)$$

$[U_1]$ and $[K_1]$ are the flow-in and flow-out for CV_2 whose state variable is $[\Omega_{CV_2}]$; $[H_{T_2}]$ is the overall level of material in T_2 ; and $[F_{out/T_2}]$ is the flow of material from T_2 and T_1 ; When CV_2 is opened, BF_{P_3} indicates that the flow of material out of T_2 (F_{out/T_2}) can increase and BF_{P_4} indicates that level of material in T_2 decreases. BF_{P_5} indicates that it helps material transfer to the reservoir tank. In qualitative terms, the effects of CV_2 in the system are:

$$CV_2 : (0 < F_{out/T_2} \leq F_{(out/T_2)max}) \wedge (H_{(T_2)min} \leq H_{T_2} < H_{T_2}^o) \wedge (K_1 > 0) \quad (5.17)$$

The reason for exploiting CV_2 can be explained in terms of these three landmark values. An explanation may include either one or all of them: *CV₂ can ease the flow of material out of T₂, reduce the level of material in this tank and transfer material to the reservoir tank.*

The possible outcomes for other components are given in Table 5.2. Note that an explanation, even if including all the effects given in Table 5.2, is neither sufficient nor necessary [25]: observing any of those effects mentioned for CV_2 does not necessarily imply that CV_2 is responsible for such observation. Also there are some other effects of CV_2 on the system due to other pairs it might take part in with the other components that such effects may not be realized by the behavior of the disjunctive processes.

Table 5.2: Contribution of components to the function of pressure tank system.

CV_1	:	$(H_{T_1}^o < H_{T_1} \leq H_{(T_1)max})$	\wedge	$(H_{(T_2)min} \leq H_{T_2} < H_{T_2}^o)$	\wedge	$(0 < F_{out/T_2} \leq F_{(out/T_2)max})$
CV_2	:	$(0 < F_{out/T_2} \leq F_{(out/T_2)max})$	\wedge	$(H_{(T_2)min} \leq H_{T_2} < H_{T_2}^o)$	\wedge	$(K_1 > 0)$
CV_3	:	$(H_{(T_1)min} \leq H_{T_1} < H_{T_1}^o)$	\wedge	$(K_2 > 0)$		
CV_4	:	$(P_{T_1}^o < P_{T_1} \leq P_{(T_1)max})$	\wedge	$(0 < A_{in/T_1} \leq A_{(in/T_1)max})$	\wedge	$(0 < A_{out/T_2} \leq A_{(out/T_2)max}) \wedge (P_{(T_2)min} \leq P_{T_2} < P_{T_2}^o)$
CV_5	:	$(P_{(T_2)min} \leq P_{T_2} < P_{T_2}^o)$	\wedge	$(0 < A_{out/T_2} \leq A_{(out/T_2)max})$	\wedge	$(J_1 > 0)$
CV_6	:	$(H_{T_2}^o < H_{T_2} \leq H_{(T_2)max})$				

5.5.5 Selection of Components

Let's have a design goal f : maintaining the level in tank T_2 . An arrangement of the components that can contribute to f is to be derived. The design specification in qualitative terms is given below.

$$\begin{aligned}
 \Gamma &= (H_{(T_2)Fix} \leq H_{T_2}) \\
 [F_1] = [G_1] &= M^+[\Omega_{CV_1}] && \text{'when'} \quad (\Omega_{CV_1} > 0) \\
 [U_1] = [K_1] &= M^+[\Omega_{CV_2}] && \text{'when'} \quad (\Omega_{CV_2} > 0) \\
 [S_1] = [E_1] &= M^+[\Omega_{CV_6}] && \text{'when'} \quad (\Omega_{CV_6} > 0) \\
 [F_{in/T_2}] &= M^+[E_1] && \text{'until'} \quad \Gamma \\
 [H_{T_2}] &= I^+[F_{in/T_2}] \\
 [H_{A/T_2}] &= I^-[G_1] && \text{'when'} \quad \Gamma \\
 [H_{B/T_2}] &= I^-[U_1] && \text{'when'} \quad \Gamma \\
 [H_{T_2}] &= M^+[H_{A/T_2}] && + \quad M^+[H_{B/T_2}]
 \end{aligned} \tag{5.18}$$

$[U_1]$, $[K_1]$, $[S_1]$ and $[E_1]$ stand for the flow-in and flow-out for CV_2 and CV_6 ; $[\Omega_{CV_1}]$, $[\Omega_{CV_2}]$ and $[\Omega_{CV_6}]$ denote state variables of the valves; $[F_{in/T_2}]$ is the flow of material into T_2 ; $[H_{T_2}]$ is the overall level of material in T_2 ; $[H_{A/T_2}]$ and $[H_{B/T_2}]$ are level of material of type A and B in T_2 ; $H_{(T_2)Fix}$ is the desired level of the tank T_2 . This model is examined for validity.

Clock constraints:

$$\begin{aligned}
 f_1^2 = g_1^2 &= \omega_{CV_1}^2(-\omega_{CV_1} - \omega_{CV_1}^2) \\
 u_1^2 = k_1^2 &= \omega_{CV_2}^2(-\omega_{CV_2} - \omega_{CV_2}^2) \\
 s_1^2 = e_1^2 &= \omega_{CV_6}^2(-\omega_{CV_6} - \omega_{CV_6}^2) \\
 f_{in/T_2}^2 &= e_1^2(-\gamma) \\
 h_{T_2}^2 &= f_{in/T_2}^2 \\
 h_{A/T_2}^2 &= g_1^2(-\gamma - \gamma^2) \\
 h_{B/T_2}^2 &= u_1^2(-\gamma - \gamma^2) \\
 (h_{T_2}^2 &= h_{A/T_2}^2) \text{ or} \\
 (h_{T_2}^2 &= h_{B/T_2}^2)
 \end{aligned}$$

Dependency constraints:

$$\begin{aligned}
 \omega_{CV_1}^2(-\omega_{CV_1} - \omega_{CV_1}^2) &: [\Omega_{CV_1}] \rightarrow M^+ \rightarrow [G_1] \\
 \omega_{CV_2}^2(-\omega_{CV_2} - \omega_{CV_2}^2) &: [\Omega_{CV_2}] \rightarrow M^+ \rightarrow [K_1] \\
 \omega_{CV_6}^2(-\omega_{CV_6} - \omega_{CV_6}^2) &: [\Omega_{CV_6}] \rightarrow M^+ \rightarrow [E_1] \\
 e_1^2(-\gamma) &: [E_1] \rightarrow M^+ \rightarrow [F_{in/T_2}] \\
 g_1^2(-\gamma - \gamma^2) &: [G_1] \rightarrow I^- \rightarrow [H_{A/T_2}] \\
 u_1^2(-\gamma - \gamma^2) &: [U_1] \rightarrow I^- \rightarrow [H_{B/T_2}]
 \end{aligned}$$

The QFG in this case is shown in Figure 5.5.5. When Γ is false ($\gamma = -1$) indicating that the desired level is not achieved, the only active process is P_6 and the level will increase. But when Γ becomes true ($\gamma = 1$), then processes P_4 and P_7 are active and P_6 is inactive. Therefore the

level decreases until Γ is violated again. Let's assume that there is no other design preference and verify which of the components are crucial to this arrangement. Deleting CV_6 and the process P_6 is equivalent to setting ($\omega_{CV_6} = 0$). It follows that the no process will be active when ($\gamma = -1$). Even if ($\gamma = 1$), P_4 and P_7 become active and simulation and cycle detection verify that they both lead to the *EMPTY* function. On the other hand, it can easily be shown that deletion of CV_1 or CV_2 (P_4 or P_7), but not both, can lead to the proper functioning. However, CV_1 and CV_2 are redundant for the given function. Let's add another preference that the level of B-liquid should not exceed a given level (in order to ensure that A-liquid cannot leak to the reservoir tank). This adds the following expressions to the model (5.18).

$$\Theta = (H_{B/T_2} \leq H_{(B/T_2)lim}) \quad (5.19)$$

$$[H_{B/T_2}] = \{I^-[U_1] \text{ 'when' } \Gamma\} \text{ 'until' } \Theta \quad (5.20)$$

Additional Clock and Dependency constraints are:

$$h_{B/T_2}^2 = u_1^2(-\gamma - \gamma^2)(-\theta) \quad (5.21)$$

$$u_1^2(-\gamma - \gamma^2)(-\theta) : [U_1] \rightarrow I^- \rightarrow [H_{B/T_2}] \quad (5.22)$$

Here when Γ is true ($\gamma = 1$), the process P_7 becomes active and P_6 is inactive. This ensures the level will be maintained. But P_4 can be active only when Θ is false ($\theta = -1$). Only in such case, it can help P_7 to regulate the level of material in T_2 . Therefore, the valves CV_1 and CV_2 contribute to the functionality of the system in different ways and cannot be deleted from the design.

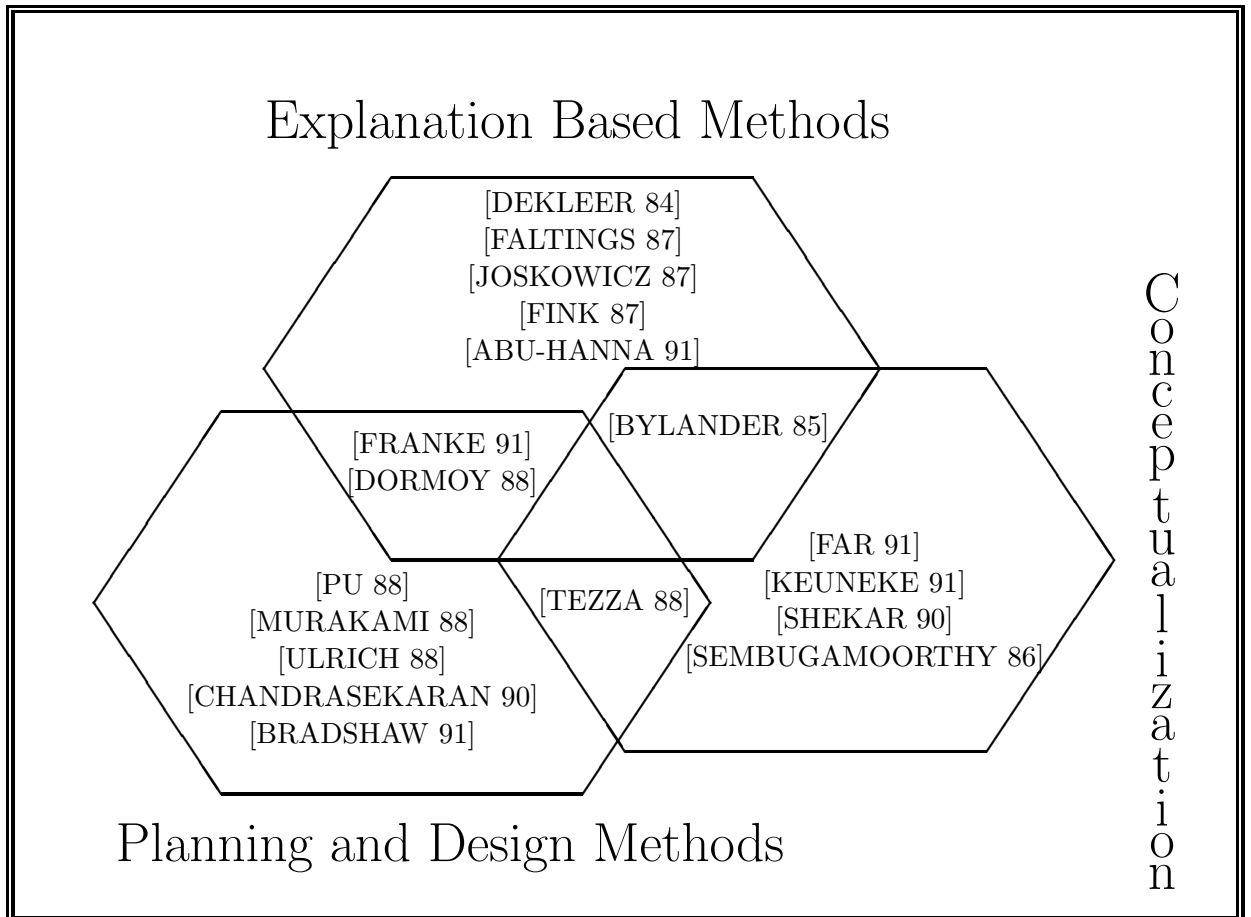

Figure 5.1: Functional reasoning techniques and systems.

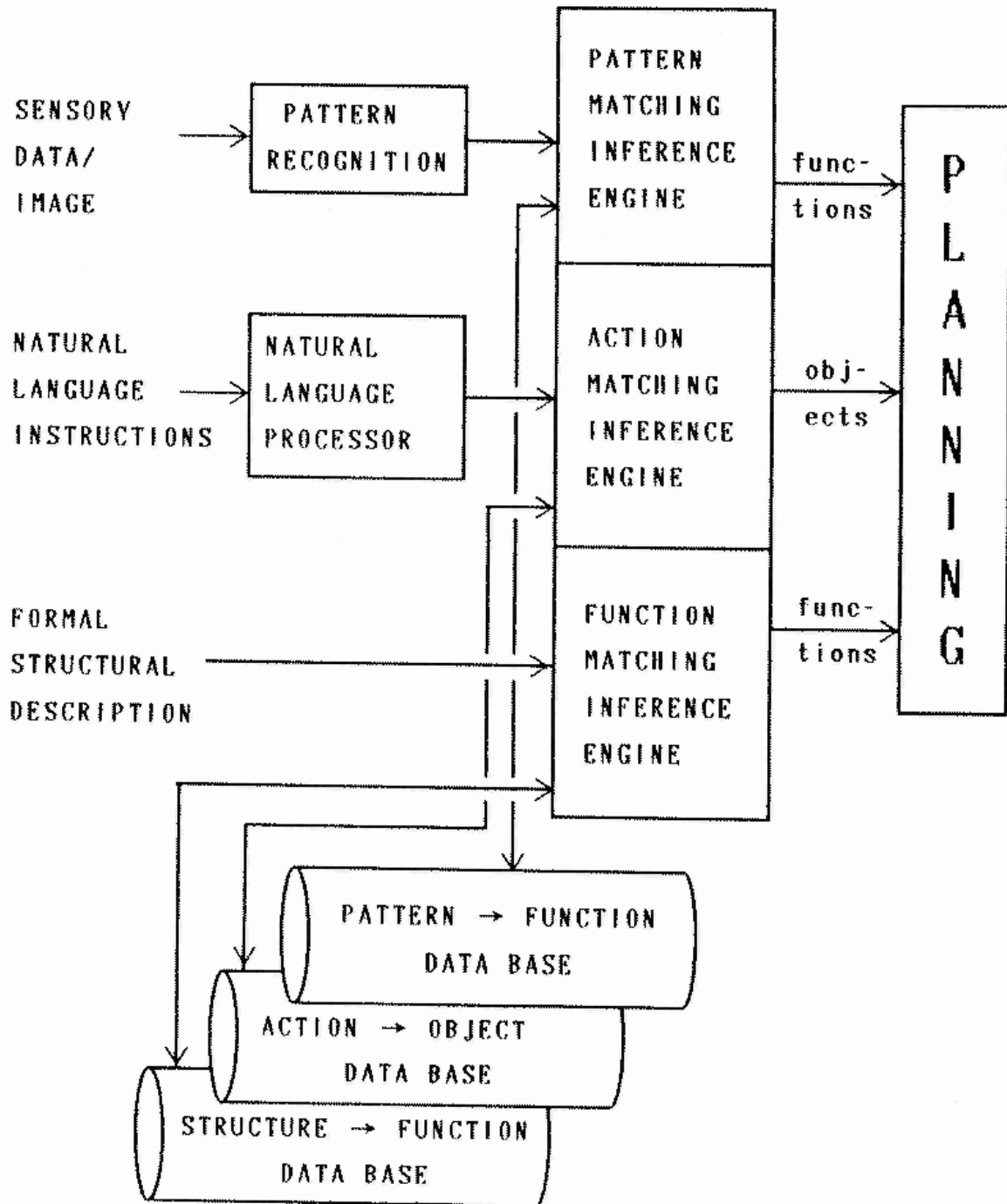

Figure 5.2: Three first generation functional reasoning systems.

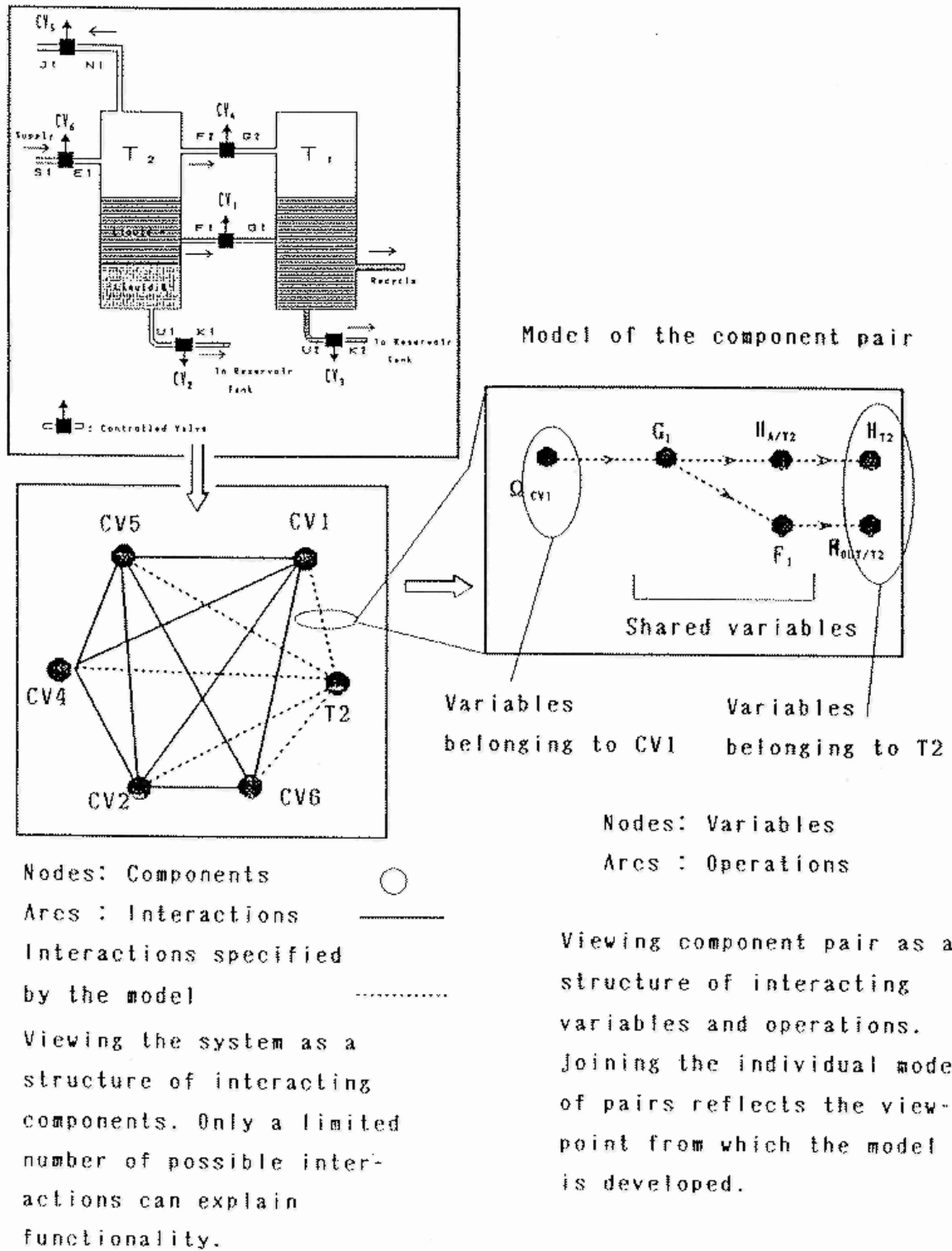

Figure 5.3: Two network models for an object.

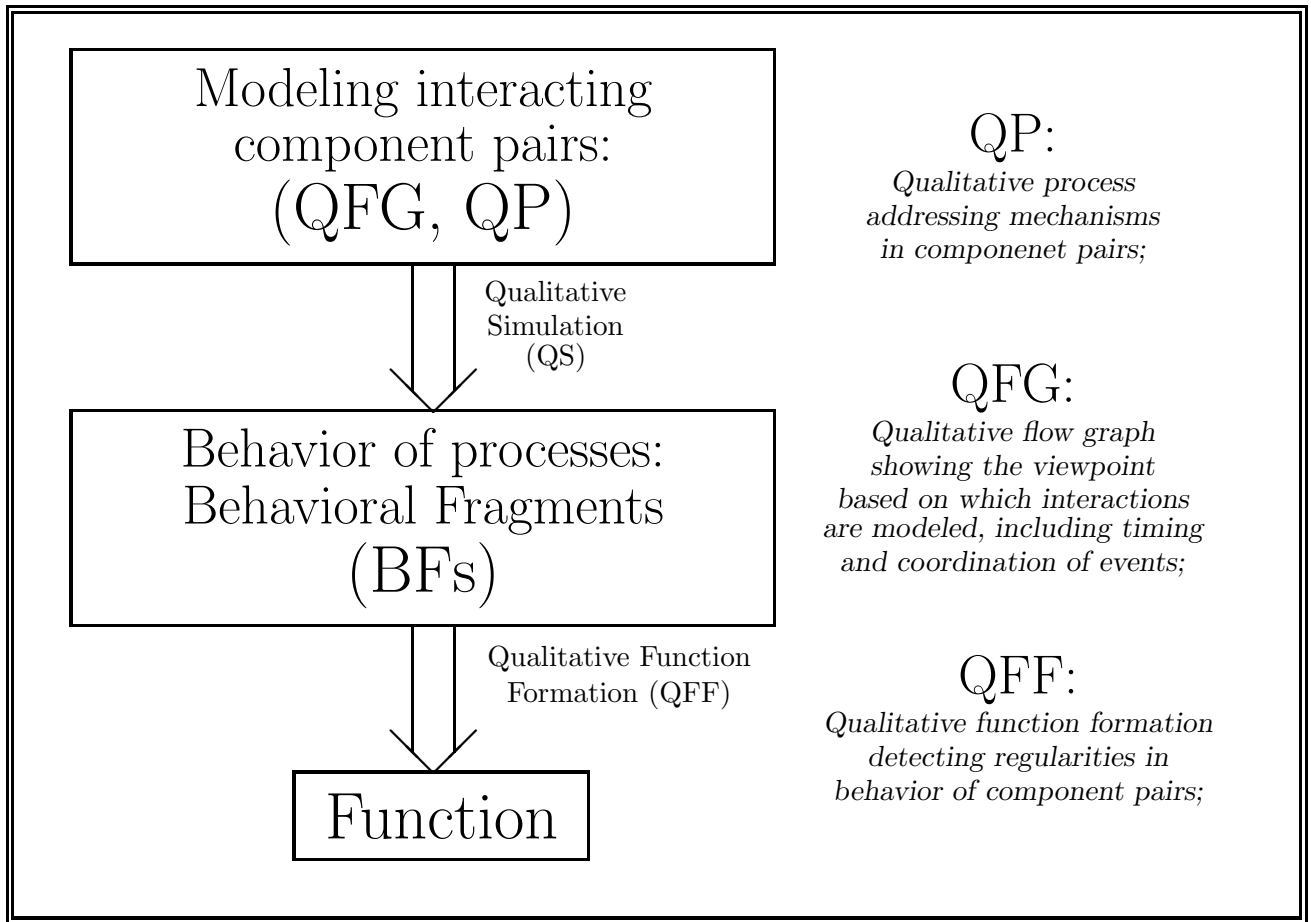

Figure 5.4: Overview of the qualitative function formation technique.

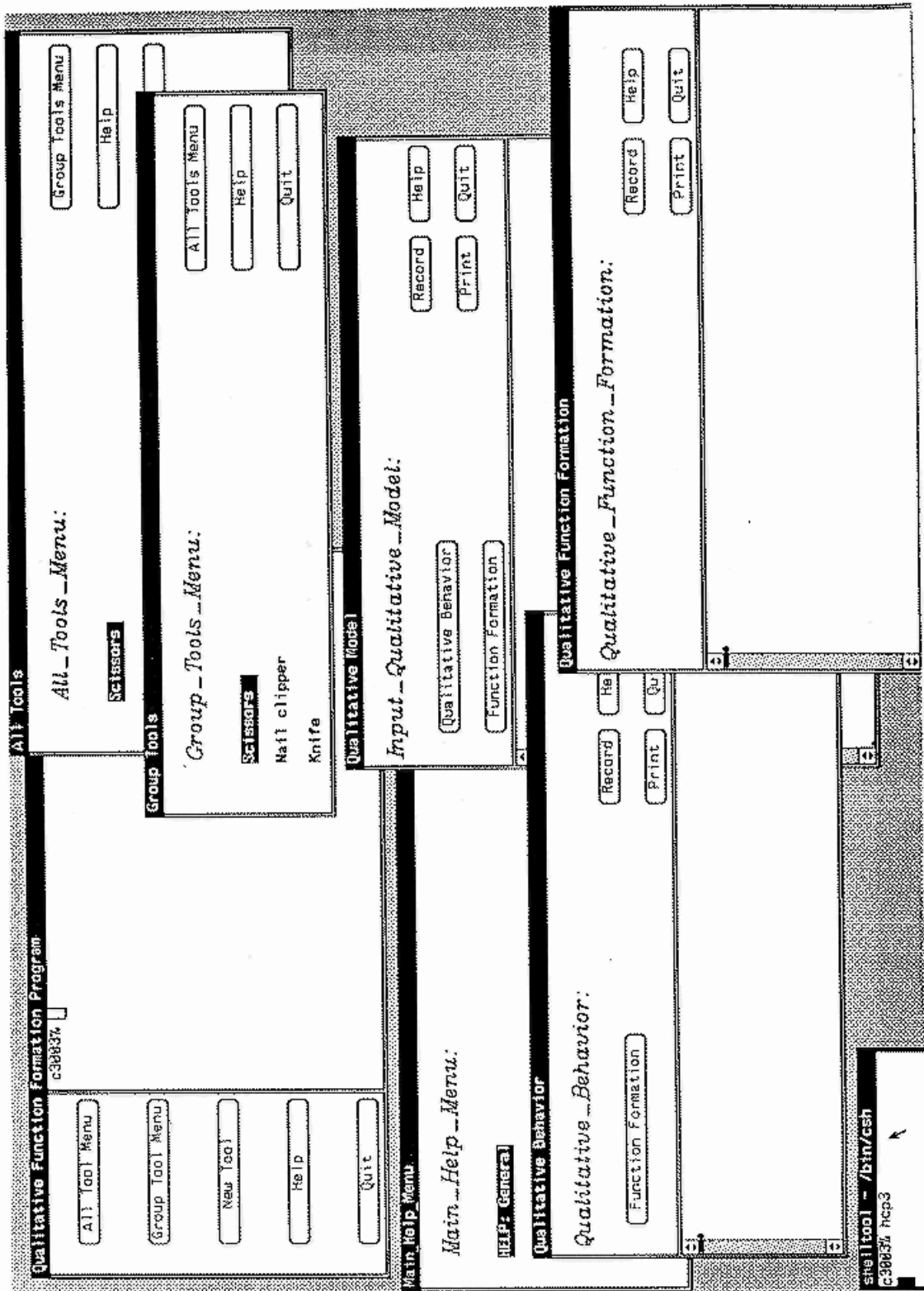

Figure 5.5: An example of windows of the qualitative function formation system.

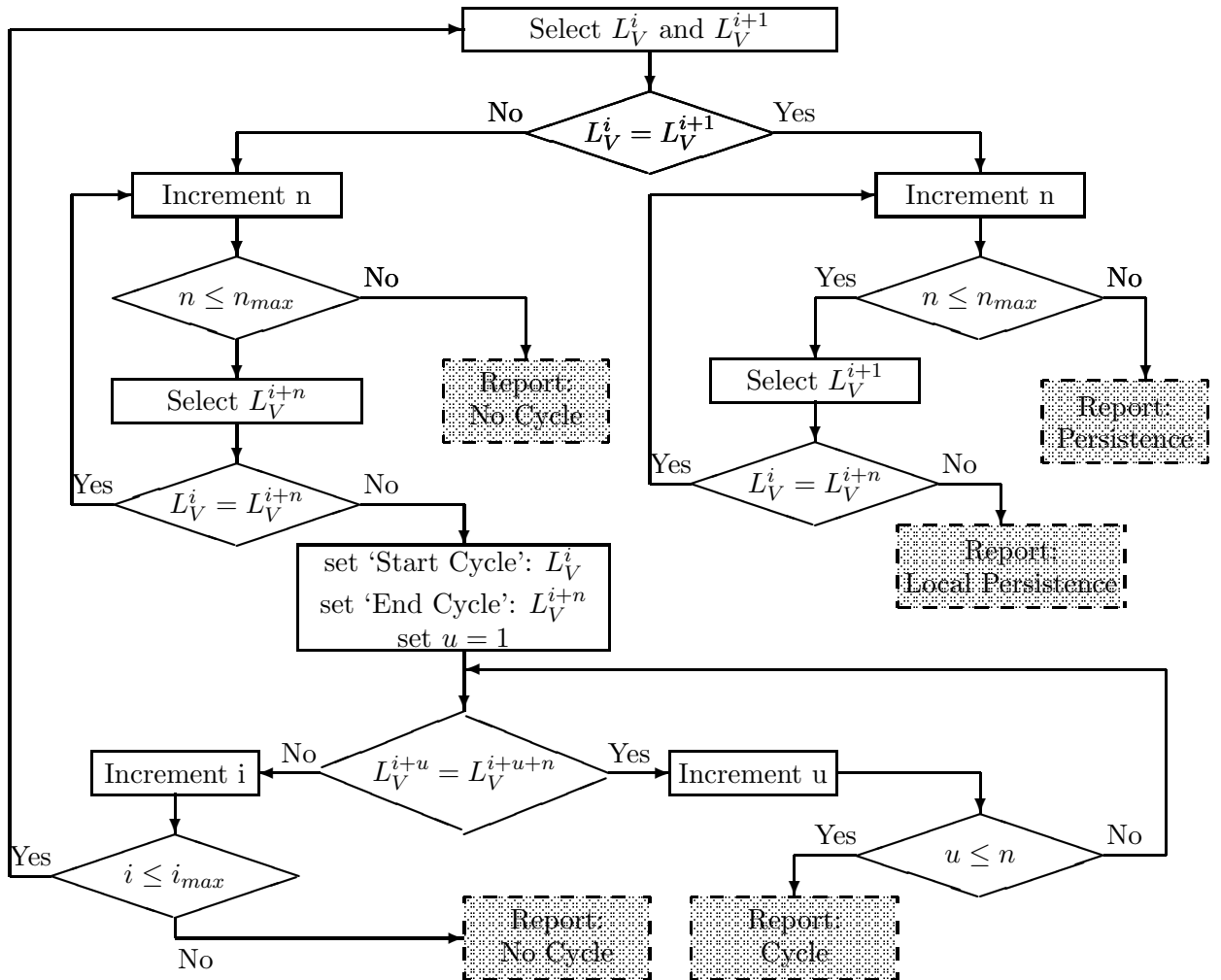

Figure 5.6: Repetition cycle detection algorithm.

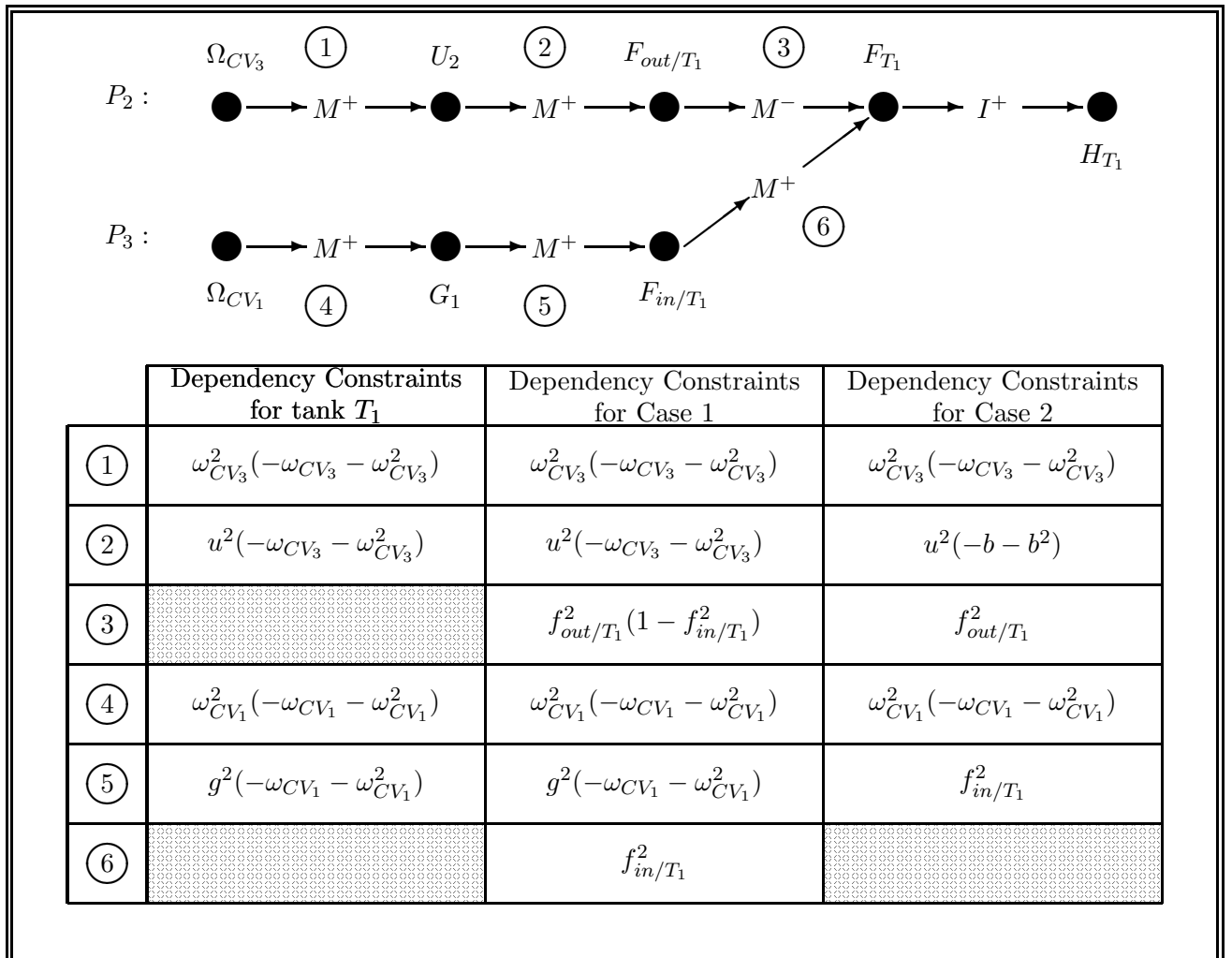

Figure 5.7: Qualitative model of the three design preferences for the tank T_1 .

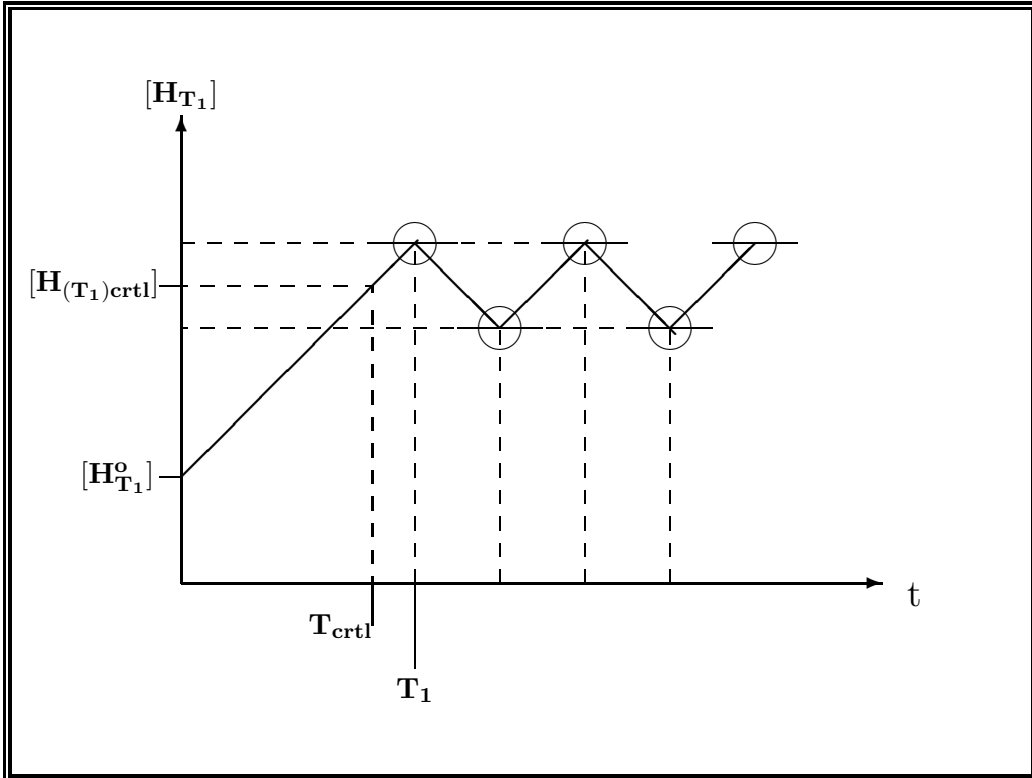

Figure 5.8: Behavior for the tank T_1 when level passes a critical value.

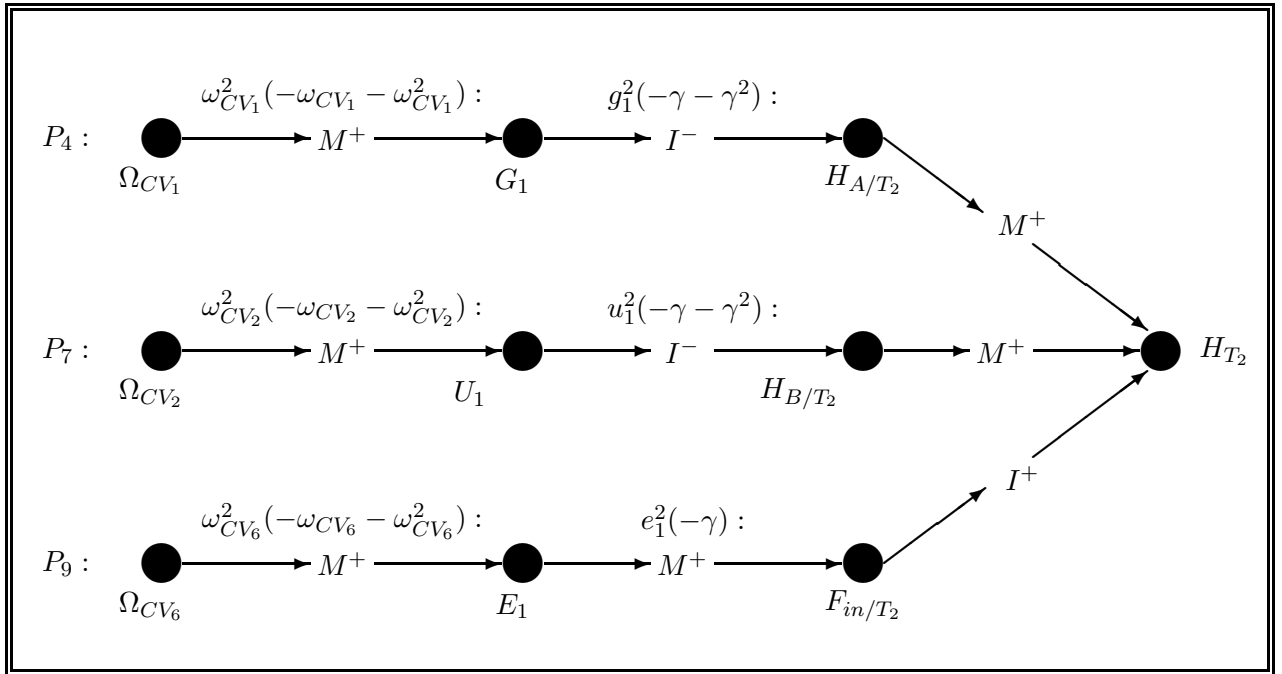

Figure 5.9: Qualitative model for the tank T_2 when the level is maintained at $H_{(T_2)fix}$.

Chapter 6

Summary

The results of two years research on application of qualitative reasoning techniques in Human Acts Simulation program (HASP) are summarized below:

6.1 A Research on Model Based Reasoning

1. Suggesting a hierarchical qualitative model corresponding to the Skill-Rule-Knowledge based reasoning (see Figure 2.5 Chapter 2);
2. Extending the common qualitative models to include “coordination” and “timing” of events by defining temporal and dependency constraints, and binding it with the conventional qualitative simulation (see Chapter 2);
3. Suggesting a method for developing “Qualitative Compiled Model” (QC_M) from the “Qualitative Deep Model” (QD_M) (see Chapter 2);
4. The results are published in [39];

6.2 A Research on Model Based Learning

1. Model based generation of “rules-of-thumb” from deep qualitative model(see Chapter 3);
2. Learning repeating procedures using “Qualitative Sensitivity Analysis” (QS_A) (see Chapter 3);
3. Model based discourse understanding using QS_A .
4. The results are published in [34] and [36].

6.3 A Research on Subjective Fault Diagnosis

1. Introducing the subjective qualitative fault diagnosis (SQD^F) embodying the *deep* and *compiled* model based techniques for detecting concurrent faults, diagnostic rule generation, discourse understanding, generating and testing concurrent fault hypotheses and situation assessment. The overview of the system is given in Figure 4.7 (see Chapter 4);
2. A hierarchy of the deep and compiled levels of SQD^F resembles the problem solving behavior of human experts in the *skill-rule-knowledge* (S-R-K) framework.
3. The results are published in [38] and [40].

6.4 A Research on Functional Reasoning

1. Reviewing the results of diverse functional reasoning researches within a variety of disciplines and identifying the common core and basic problems. A major achievement is putting the ideas and assumptions in the functional reasoning on a more concrete basis (see Chapter 5);
2. Defining function concepts as interpretations of either a persistence or an order in the sequence of states, using the trace of the qualitative state vector derived by qualitative simulation on the extended qualitative model.
3. Suggesting the “Qualitative Function Formation” (QFF) technique for deriving function of tools and objects from their qualitative model. QFF is a general method for deriving the function from the qualitative behavior. The overview of QFF is given in Figure 5.5.5 of Chapter 5;
4. Providing solution to some of the functional reasoning problems.
5. Suggesting a method for generalization and comparison of functions of different objects. Typical applications of QFF in functional design of artifacts was introduced.
6. The results are published in [39];

Acknowledgment

I am grateful to Professor Matsuroh Nakamichi of Chiba University who introduced me to the problems described here and supervised it. His numerous advises were of greatest importance during development phases of this work. The environment of Computing and Information Systems Center (CISC) of Japan Atomic Energy Research Institute (JAERI) provided valuable support and stimulation for this project. I had useful discussions with Messrs Kiyoshi Asai (Office of Planning, JAERI), Masayuki Akimoto, Minoru Fujii, Kenji Higuchi, Etsuo Kume, Takayuki Ohtani, Shaw Kambayashi (CISC) and Yasuaki Abe (CSK Co.). I should specially thank Mr. Yoshio Otaka and all the staff of CISC who contributed to this work in many ways. I am are grateful to them all.

Bibliography

- [1] A. Abu-Hanna and Y.I. Gold, "Adaptive Multilevel Diagnosis and Modeling of Dynamic Systems," *Int. J. Expert Systems*, vol. 3, no. 1, pp. 1-30, 1990.
- [2] A. Abu-Hanna, R. Benjamins and W. Jansweijer, "Device Understanding and Modeling for Diagnosis," *IEEE Expert*, vol. 6, no. 2, pp. 26-32, April 1991.
- [3] L. Acar and U. Ozguner, "Design of Knowledge-Rich Hierarchical Controllers for Large Functional Systems," *IEEE Trans. System, Man, and Cybernet.*, vol. SMC-20, no. 4, pp. 791-803, July/August 1990.
- [4] D.M. Allan, "Towards a Natural Teleology," *J. of Philosophy*, vol. 49, pp. 449-459, 1952.
- [5] K. Asai, J. Uenaka, S. KambayasiI, K. Higuchi, E. Kume, T. Otani, M. Fujii and M. Fujisaki, "HASP: Human Acts Simulation Program," in *Proc. 1st Int. Conf. Supercomputing in Nuclear Applications (SNA' 90)*, Mito, Japan, March 1990, pp. 611-615.
- [6] F.J. Ayala, "Teleological Explanation in Evolutionary Biology," *Philosophy of Science*, vol. 37, no. 1, pp. 1-15, March 1970.
- [7] L. Bainbridge, "Types of Representation," in *Tasks, Errors and Mental Models*, L.P. Goodstein, H.B. Andersen and S.E. Olsen, eds. Taylor and Francis, 1988, ch. 4, pp. 70-91.
- [8] S. Baron, C. Feehrer, R. Muralidhahran, R. Pew and P. Horwitz, "A Framework for Modeling Supervisory Control Behavior of Operators of Nuclear Power Plants," in *Proc. Workshop on Cognitive Modeling of Nuclear Plant Control Room Operators*, ORNL TM-8614, Dedham, MA, Aug. 1982, pp. 36-51.
- [9] M. Basseville, "Detecting Changes in Signals and Systems—A Survey," *Automatica*, vol. 24, no. 3, pp. 309-326, 1988.
- [10] A. Benveniste and P. LeGuernic, "Hybrid Dynamical Systems Theory and the SIGNAL language," *IEEE Trans. Automatic Control*, vol. 35, no. 5, pp. 535-546, May 1990.
- [11] J. Bigelow and R. Pargetter, "Functions," *J. of Philosophy*, vol. 84, no. 4, pp. 181-197, 1987.
- [12] D.G. Bobrow (ed.) "Special Issue on Qualitative Reasoning About Physical System," *Artif. Intell.*, vol. 24, 1984.
- [13] J.A. Bradshaw and R.M. Young, "Evaluating Design Using Knowledge of Purpose and Knowledge of Structure," *IEEE Expert*, vol. 6, no. 2, pp. 33-40, April 1991.
- [14] M. Brady and J. Connell, "Generating and Generalizing Models of Visual Objects," *Artif. Intell.*, vol. 31, pp. 159-183, 1987.
- [15] M.A. Breuer and A.D. Freidman, *Diagnosis and Reliable Design of Digital Systems*, Computer Science Press, 1976.
- [16] T. Bylander and B. Chandrasekaran, "Understanding Behavior Using Consolidation," in *Proc. 9th Int. Joint Conf. on Artif. Intell. (IJCAI' 85)*, LA, CA, 1985, pp. 450-454.

- [17] T. Bylander, "A Critique of Qualitative Simulation from a Consolidation Viewpoint," *IEEE Trans. System, Man, Cybernet.*, vol. SMC-18, no. 2, pp. 252-263, March/April 1988.
- [18] P.C. Cacciabue and U. Bersini, "Modeling Human Behavior in the Context of a Simulation of Man-Machine Systems," in *Training, Human Decision Making and Control*, J. Patrik and K.D. Duncan, eds., Elsevier Science Publishers, 1988, pp. 223-241.
- [19] J. Canfield, "Teleological Explanations in Biology," *British J. of Philosophy of Science*, vol. 14, 1964.
- [20] J.G. Carbonell, "Paradigms for Machine Learning," *Artif. Intell.*, vol. 40, pp. 1-9, 1989.
- [21] B. Chandrasekaran, "Design Problem Solving: A Task Analysis," *AI Magazine*, Special Issue on AI and Design, vol. 11, no. 4, pp. 59-71, Winter 1990.
- [22] E.Y. Chow and A.S. Willsky, "Analytical Redundancy and the Design of Robust Failure Detection Systems," *IEEE Trans. Automatic Control*, vol. AC-29, pp. 603-614, 1984.
- [23] R.N. Clark, "Instrument Fault Detection," *IEEE Trans. Aerospace Electronic Systems*, vol. 14, pp. 456-465, 1978.
- [24] J. Cunningham, "Comprehension by Model-Building as a Basis for an Expert system," in *Expert Systems' 85*, Proc. 5th Tech. Conf. British Computer Soc., Specialist Group on Expert Systems, British Inf. Soc. Ltd., 1985, pp. 259-272.
- [25] R. Cummins, "Functional Analysis," *J. of Philosophy*, vol. 72, no. 20, pp.741-765, 1975.
- [26] R. Cummins, "Dispositions, States and Causes," *Analysis*, vol. 34.6, no. 162, pp. 194-204, June 1974.
- [27] J.D. DeKleer, "How Circuits Work," *Artif. Intell.*, vol. 24, pp. 205-280, 1984.
- [28] J.D. DeKleer and J.S. Brown, "A Qualitative Physics Based on Confluences," *Artif. Intell.*, vol. 24, pp. 7-83, 1984.
- [29] J.D. Dekleer and B.C. Williams, "Diagnosing Multiple Faults," *Artif. Intell.*, vol. 32, pp. 97-130, 1987.
- [30] J.L. Dormoy and O. Raiman, "Assembling a Device," in *Proc. 7th National Conf. on Artif. Intell. (AAAI'88)*, Saint Paul, MN, July 1988, pp. 330-335.
- [31] T. Ellman, "Explanation-Based Learning: A survey of Programs and Perspectives," *ACM Computing Surveys*, vol. 21, no. 2, pp. 163-221, June 1989.
- [32] B. Faltings, "Qualitative Kinematics in Mechanisms," in *Proc. 10th Int. Joint Conf. on Artif. Intell. (IJCAI' 87)*, Milan, Italy, 1987, pp. 436-442.
- [33] B. Faltings, "Qualitative Kinematics in Mechanisms," *Artif. Intell.*, vol. 44, pp. 89-119, 1990.
- [34] B.H. Far, M. Nakamichi and M. Sampei, "Automatic Diagnostic Rule Generation for Rule-Based Controllers by Qualitative Sensitivity Analysis," *Trans. Institute of Electrical Engineers Japan*, vol. 110C, no. 10, pp. 661-669, Oct. 1990.
- [35] B.H. Far, "Task Planning, Motion Planning and Assessment of Plans," In *HASP: Human Acts Simulation Program, A Study on Intelligent Nuclear Systems*, JAERI-M 91-101, Chapter 4, pp. 40-56, 1991.
- [36] B.H. Far, M. Nakamichi and M. Sampei, "Qualitative Sensitivity Analysis," *J. Japanese Society for Artif. Intell.*, vol. 6, no. 1, pp. 84-95, Jan. 1991.

- [37] B.H. Far, M. Nakamichi and M. Sampei, "Qualitative Supervisory Control Featuring Cognitive Capabilities of The Domain Practitioners," in *Proc. 2nd Makuhari Int. Conf. on High Technology (MIGHT' 91)*, Chiba, Japan, Feb. 1991, pp. 135-138.
- [38] B.H. Far and M. Nakamichi, "A Subjective Approach to Qualitative Fault Diagnosis in Systems With Nonintermittent Multiple Faults," in *Proc. 5th Annual Conf. of Japanese Society for Artificial Intelligence (JSAI' 91)*, Tokyo, Japan, June 1992, pp. 685-688.
- [39] B.H. Far, "Functional Reasoning, Explanation and Analysis," *JAERI-M 91-225*, Japan Atomic Energy Research Institute, Tokai, Japan, Jan. 1992.
- [40] B.H. Far, "Qualitative Fault Diagnosis in Systems With Nonintermittent Concurrent Faults: A Subjective Approach," to appear in *IEEE Trans. System, Man, Cybernet.*, 1992.
- [41] R.E. Fikes and N.J. Nilsson, "STRIPS: A New Approach to the Application of Theorem Proving to Problem Solving," *Artif. Intell.*, vol. 2, pp. 189-208, 1971.
- [42] P.K. Fink, "Control and Integration of Diverse Knowledge in a Diagnostic Expert System," in *Proc. 9th Int. Joint Conf. on Artif. Intell. (IJCAI' 85)*, LA, CA, 1985, pp. 426-431.
- [43] P.K. Fink and J.C. Lusth, "Expert Systems and Diagnosis Expertise in the Mechanical and Electrical Domains," *IEEE Trans. System, Man, Cybernet.*, vol. SMC-17, no. 3, pp. 340-349, May/June 1987.
- [44] D. Fisher and P. Langley, "Approaches to Conceptual Clustering," in *Proc. 9th Int. Joint Conf. on Artif. Intell. (IJCAI' 85)*, LA, CA, 1985, pp. 691-697.
- [45] K.D. Forbus, "Qualitative Process Theory," *Artif. Intell.*, vol. 24, pp. 85-168, 1984.
- [46] K.D. Forbus, P. Nielsen and B. Faltings, "Qualitative Kinematics: A Framework," in *Proc. 10th Int. Joint Conf. on Artif. Intell. (IJCAI' 87)*, Milan, Italy, 1987, pp. 430-435.
- [47] K.D. Forbus, "Interpreting Observations of Physical Systems," *IEEE Trans. System, Man, Cybernet.*, vol. SMC-17, no. 3, pp. 350-359, May/June 1987.
- [48] P.M. Frank, "Fault Diagnosis in Dynamic Systems Using Analytical and Knowledge Based Redundancy—A Survey and Some New results," *Automatica*, vol. 26, no. 3, pp. 459-474, 1990.
- [49] D.W. Franke, "Deriving and Using Descriptions of Purpose," *IEEE Expert*, vol. 6, no. 2, pp. 41-47, April 1991.
- [50] P. Freeman and A. Newell, "A Model for Functional Reasoning in Design," in *Advanced Papers of 2nd Int. Joint Conf. on Artif. Intell. (IJCAI' 71)*, London, 1971, pp. 621-640.
- [51] J.B. Fussell, "A Formal Methodology for Fault Tree Construction," *Nuclear Sci. and Engineering*, vol. 52, pp. 421-432, 1973.
- [52] M.R. Genesereth, "The Use of Design Descriptions in Automated Diagnosis," *Artif. Intell.*, vol. 24, pp. 411-436, 1984.
- [53] M.P. Georgeff and U. Bunollo, "Procedural Expert Systems," in *Proc. 8th Int. Joint Conf. on Artif. Intell. (IJCAI' 83)*, Karlsruhe, Germany, 1983, pp. 151-157.
- [54] M.P. Georgeff and A.L. Lansky, "Procedural Knowledge," *Proc. IEEE*, vol. 74, no. 10, pp. 1383-1397, 1986.
- [55] M.L. Ginsberg and D.E. Smith, "Reasoning about Action I: A Possible Worlds Approach," *Artif. Intell.*, vol. 35, pp. 165-195, 1988.

- [56] F. Gomez and B. Chandrasekaran, "Knowledge Organization and Distribution for Medical Diagnosis," *IEEE Trans. System, Man, Cybernet.*, vol. SMC-11, no. 1, pp. 34-42, Jan. 1981.
- [57] J. Gordon and E.H. Shortliffe, "The Dempster-Shafer Theory of Evidence," in *Rule-based Expert Systems*, B.C. Buchanan and E.H. Shortliffe, eds., Addison-Wesley, 1984, ch. 13, pp. 272-292.
- [58] T.P. Hamilton, "An Application of Qualitative Physics to Diagnostics in Advanced Helicopters," *Abstracts Qualitative Physics Workshop*, Urbana-Champaign, IL, 1987.
- [59] P. Hayes, "The Naive Physics Manifesto," in *Phil. of Artif. Intell.*, M.A. Boden, ed., Oxford Univ. Press, 1990, Chapter 8.
- [60] P. Hayes, "Naive Physics 1: Ontology for Liquids," in *Formal Theories of the Common Sense World*, J.R. Hobbs and R.C. Moore, eds., Ablex, NJ, 1979, pp. 71-107.
- [61] P. Hayes, "The Second Naive Physics Manifesto," in *Readings in Cognitive Science*, A. Collins and E.E. Smith, eds., Morgan Kaufmann, 1985, pp. 468-485.
- [62] C.G. Hempel, "The logic of Functional Analysis," in *Symposium on Sociological Theory*, L. Gross, ed., Harper and Row, New York, 1959.
- [63] J.M. Hoc, "Strategies in Controlling a Continuous Process with Long Response Latencies: Needs for Computer Support to Diagnosis," *Int. J. Man Machine Studies*, vol. 30, pp. 47-67, 1989.
- [64] R. Isermann, "Process Fault Detection Based on Modeling and Estimation Methods- A Survey," *Automatica*, vol. 20, no. 4, pp. 387-404, 1984.
- [65] Y. Iwasaki and H.A. Simon, "Causality in Device Behavior," *Artif. Intell.*, vol. 29, pp. 3-32, 1986.
- [66] G. Johannsen, "Categories of Human Operator Behavior in Fault Management Situations," in *Tasks, Errors and Mental Models*, L.P. Goodstein, H.B. Andersen and S.E. Olsen, eds., Taylor and Francis, 1988, ch. 16, pp. 251-258.
- [67] L. Joskowicz, "Shape and Function in Mechanical Devices," in *Proc. 6th National Conf. on Artif. Intell. (AAAI'87)*, Seattle, WA, July 1987, pp. 611-615.
- [68] L. Joskowicz and S. Addanki, "From Kinematics to Shape: An approach to Innovative Design," in *Proc. 7th National Conf. on Artif. Intell. (AAAI'88)*, Saint Paul, MN, July 1988, pp. 347-352.
- [69] A.M. Keuneke, "Device Representation: The Significance of Functional Knowledge," *IEEE Expert*, vol. 6, no. 2, pp. 22-25, April 1991.
- [70] J.L. Knight, "Manual Control and Tracking," in *Handbook of Human Factors*, G. Galvandy, ed., Wiley, 1987, ch. 2.7, pp. 183-217.
- [71] B. Kuipers, "Qualitative Simulation," *Artif. Intell.*, vol. 29, pp. 289-338, 1986.
- [72] B. Kuipers, "Qualitative Reasoning with Causal Models in Diagnosis of Complex Systems," in *Artificial Intelligence, simulation, and Modeling*, L.E. Widman, K.A. Loparo and R.A. Nielsen, eds., Wiley, 1989, ch. 10, pp. 257-274.
- [73] H. Lehman, "Functional Explanations in Biology," *Philosophy of Science*, vol. 32, no. 1, pp. 1-20, January 1965.
- [74] M. Lind, "System Concepts and the Design of Man-Machine Interfaces for Supervisory Control," in *Tasks, Errors and Mental Models*, L.P. Goodstein, H.B. Andersen and S.E. Olsen, eds., Taylor and Francis, 1988, ch. 18, pp. 269-277.

- [75] M. Matthen, "Biological Functions and Perceptual Content," *J. of Philosophy*, vol. 85, pp. 5-27, 1988.
- [76] R. Milne, "Fault Diagnosis Through Responsibility," in *Proc. 9th Int. Joint Conf. on Artif. Intell. (IJCAI' 85)*, LA, CA, 1985, pp. 423-425.
- [77] R. Milne, "Strategies for Diagnosis," *IEEE Trans. System, Man, Cybernet.*, vol. SMC-17, no. 3, pp. 333-339, May/June 1987.
- [78] R. Milne, "Artificial Intelligence for Online Diagnosis," *Proc. IEE*, vol. 134, Pt.D, no. 4, pp. 238-244, 1987.
- [79] T.P. Moran, "An Applied Psychology of the User," *Computing Surveys*, vol. 13, no. 1, pp. 1-11, March 1981.
- [80] T. Murakami and N. Nakajima, "Computer-Aided Design- Diagnosis Using Feature Description," in *Artif. Intell. in Engineering: Diagnosis and Learning*, J.S. Gero, ed., Elsevier, 1988, pp.199-226.
- [81] E. Nagel, "Teleology Revisited: Goal Directed Processes in Biology," *J. of Philosophy*, vol. 74, no. 5, pp. 261-279, 1977.
- [82] E. Nagel, "Teleology Revisited: Functional Explanation in Biology," *J. of Philosophy*, vol. 74, no. 5, pp. 280-301, 1977.
- [83] T. Nishida and S. Doshita, "Reasoning about Discontinuous Change," in *Proc. 6th National Conf. on Artif. Intell. (AAAI'87)*, Seattle, WA, July 1987, pp. 643-648.
- [84] A. Paterson, P. Sachs and M. Turner, "ESCORT: The Application of Causal Knowledge to Real-Time Process Control," in *Expert Systems' 85*, Proc. of the 5th Tech. Conf. of The British Computer Soc. Specialist Group on Expert Systems, British Information Soc. Ltd., 1985, pp. 79-88.
- [85] M.J. Pazzani, "Failure Driven Learning of Fault Diagnosis Heuristics," *IEEE Trans. System, Man, Cybernet.*, vol. SMC-17, no. 3, pp. 380-394, May/June 1987.
- [86] P. Pu and N.I. Badler, "Design Knowledge Capturing for Device Behavior Reasoning," in *Artif. Intell. in Engineering: Design*, J.S. Gero, ed., Elsevier, 1988, pp. 37-56.
- [87] J. Rasmussen, "On the Structure of Knowledge- A Morphology of Mental Models in a Man-Machine System Context," *Riso Report Riso-M-2357*, Riso National Laboratory, Denmark, 1979.
- [88] J. Rasmussen, "Skills, Rules and Knowledge: Signals, Signs, and Symbols, and Other Distinctions in Human Performance Models," *IEEE Trans. System, Man, and Cybernetics*, vol. SMC-13, no. 3, pp. 257-266, May 1983.
- [89] J. Rasmussen, "The Role of Hierarchical Knowledge Representation in Decision Making and System Management," *IEEE Trans. System, Man, Cybernet.*, vol. SMC-15, no. 2, pp. 234-243, March/April 1985.
- [90] J. Rasmussen and L.P. Goodstein, "Decision Support in Supervisory Control of High-risk Industrial Systems," *Automatica*, vol. 23, no. 5, pp. 663-671, 1987.
- [91] J. Rasmussen, "Human Error and the problem of Causality in Analysis of Accidents," *Phil. Trans. Royal Society London*, vol. B327, pp. 449-462, 1990.
- [92] J. Reason, "Framework Models of Human performance and Error- A Consumer Guide," in *Tasks, Errors and Mental Models*, L.P. Goodstein, H.B. Andersen and S.E. Olsen, eds., Taylor and Francis, 1988, ch. 2, pp. 35-49.

- [93] R. Reiter, "A Theory of Diagnosis From First Principles," *Artif. Intell.*, vol. 32, pp. 57-95, 1987.
- [94] J. Rothenberg, "The Nature of Modeling," in *Artificial Intelligence, simulation and Modeling*, L.E. Widman, K.A. Loparo and R.A. Nielsen, eds., Wiley, 1989, ch. 2, pp. 75-92.
- [95] W.B. Rouse and S.H. Rouse, "Measures of Complexity of Fault Diagnosis Tasks," *IEEE Trans. System, Man, Cybernet.*, vol. SMC-9, no. 11, pp. 720-727, Nov. 1979.
- [96] W.B. Rouse, "Outlines of a Model of Human Problem Solving in Failure Situations," in *Proc. Workshop on Cognitive Modeling of Nuclear Plant Control Room Operators*, ORNL TM-8614, Dedham, MA, Aug. 1982, pp. 117-123.
- [97] W.B. Rouse, "Models of Human Problem Solving: Detection, Diagnosis and Compensation for System Failures," *Automatica*, vol. 19, no. 6, pp. 613-625, 1983.
- [98] M. Ruse, "Function Statements in Biology," *Philosophy of Science*, vol. 38, no. 1, pp. 87-95, March 1971.
- [99] P.M. Sanderson and K. Harwood, "The Skills, Rules and Knowledge Classification: A Discussion of Its Emergence and Nature," in *Tasks, Errors and Mental Models*, L.P. Goodstein, H.B. Andersen and S.E. Olsen, eds., Taylor and Francis, 1988, ch. 1, pp. 21-34.
- [100] P. Schaefer, "Higher Level Causal Reasoning for Diagnosis," in *Proc. IEEE Int. Workshop on Artif. Intell. for Industrial App.*, Hitachi, Japan, May 1988, pp. 33-38.
- [101] V. Sembugamoorthy and B. Chandrasekaran, "Functional Representation of Devices and Compilation of Diagnostic Problem Solving Systems," in *Experience, Memory and Reasoning*, J.L. Kolodner and C.K. Reisbeck, eds., Lawrence Erlbaum, Hillsdale, NJ, 1986, pp.47-73,
- [102] B. Shekar, "Temporal Sequencing of Concepts in a Functional Knowledge Base," in *Proc. Pacific Rim Int. Conf. on Artif. Intell. (PRICAI'90)*, Tokyo, Japan, November 1990, pp. 699-704.
- [103] R. Shank and R. Abelson, *Scripts, Plans, Goals and Understanding, An inquiry into Human Knowledge Structure*, Lawrence Erlbaum, 1977.
- [104] T.B. Sheridan, "Supervisory Control," in *Handbook of Human Factors*, G. Salvendy, ed., Wiley, 1987, ch. 9.6, pp. 1243-1268.
- [105] J. Shiozaki, B. Shibata, H. Matsuyama and E. Oshima, "Fault Diagnosis of Chemical Processes Utilizing Signed Directed Graphs Improvement by Temporal Information," in *Proc. IEEE Int. Workshop on Artif. Intell. for Industrial App.*, Hitachi, Japan, May 1988, pp. 461-466.
- [106] J. Shrager, D. Jordan, T. Moran, G. Kiczales and D. Russell, "Issues in the Pragmatics of Qualitative Modeling: Lessons Learned from a Xerographics Project," *Communic. ACM*, vol. 30, no. 12, pp. 1036-1047, 1987.
- [107] D.P. Siewiorek and L.K. Lai, "Testing of Digital Systems," *Proc. IEEE*, vol. 69, no. 10, pp. 1321-1333, Oct. 1981.
- [108] H.A. Simon, *The Sciences of the Artificial*, MIT Press 1969.
- [109] R. Sorabji, "Function," *Phil. Quarterly*, vol. 14, no. 57, pp. 289-302, October 1964.
- [110] D. Steier, "Creating a Scientific Community at the Interface Between Engineering Design and AI," *AI Magazine*, Special Issue on AI and Design, vol. 11, no.4, pp. 18-22, Winter 1990.
- [111] J. Sticklen and W.E. Bond, "Functional Reasoning and Functional Modeling," *IEEE Expert*, vol. 6, no. 2, pp. 20-21, April 1991.

- [112] P. Struss, "Extensions to ATMS-based Diagnosis," in *Artificial Intelligence in Engineering: Diagnosis and Learning*, J.S. Gero, ed., Elsevier, 1988, pp. 3-28.
- [113] T. Tezza and E. Trucco, "Functional Reasoning for Flexible Robots," in *Artificial Intelligence in Engineering: Robotics and Processes*, J.S. Gero, ed., Elsevier, 1988, pp. 3-19.
- [114] P.W. Thorndyke, "A Rule-Based Approach to Cognitive Modeling of Real-Time Decision Making," in *Proc. Workshop on Cognitive Modeling of Nuclear Plant Control Room Operators*, ORNL TM-8614, Dedham, MA, Aug. 1982, pp. 147-155.
- [115] K.T. Ulrich and W.P. Seering, "Function Sharing in Mechanical Design," in *Proc. 7th National Conf. on Artif. Intell. (AAAI'88)*, Saint Paul, MN, July 1988, pp. 342-346.
- [116] B. Wahlstrom, "On the Use of Models in Human Decision-Making," in *Tasks, Errors and Mental Models*, L.P. Goodstein, H.B. Andersen and S.E. Olsen, eds., Taylor and Francis, 1988, ch. 10, pp. 161-170.
- [117] D.S. Weld, "Combining Discrete and Continuous Process Models," in *Proc. 9th Int. Joint Conf. on Artif. Intell. (IJCAI' 85)*, LA, CA, 1985, pp. 140-143.
- [118] D.S. Weld, "The Use of Aggregation in Causal Simulation," *Artif. Intell.*, vol.30, no.1, pp.1-34 1986.
- [119] M.D. Williams, T.P. Moran and J.S. Brown, "The Role of Conceptual Models in Nuclear Power Plant Operation," in *Proc. Workshop on Cognitive Modeling of Nuclear Plant Control Room Operators*, ORNL TM-8614, Dedham, MA, Aug. 1982, pp. 107-116.
- [120] L. Wright, "Functions," *Phil. Review*, vol.82, no.2, pp.139-168, April 1973.
- [121] L. Wright, *Teleological Explanations*, University of California Press, 1976.
- [122] J. Yen, "GERTIS: A Dempster-Shafer Approach to Diagnosing Hierarchical Hypotheses," *Communic. ACM*, vol. 32, no. 5, pp. 573-585, 1989.
- [123] W.C. Yoon and J.M. Hammer, "Deep Reasoning Fault Diagnosis: An Aid and a Model," *IEEE Trans. System, Man, Cybernet.*, vol. 18, no. 4, pp. 659-676, July/Aug. 1988.